

alca

Service Instructions for Alca Concealed Cistern

www.alcadrain.com

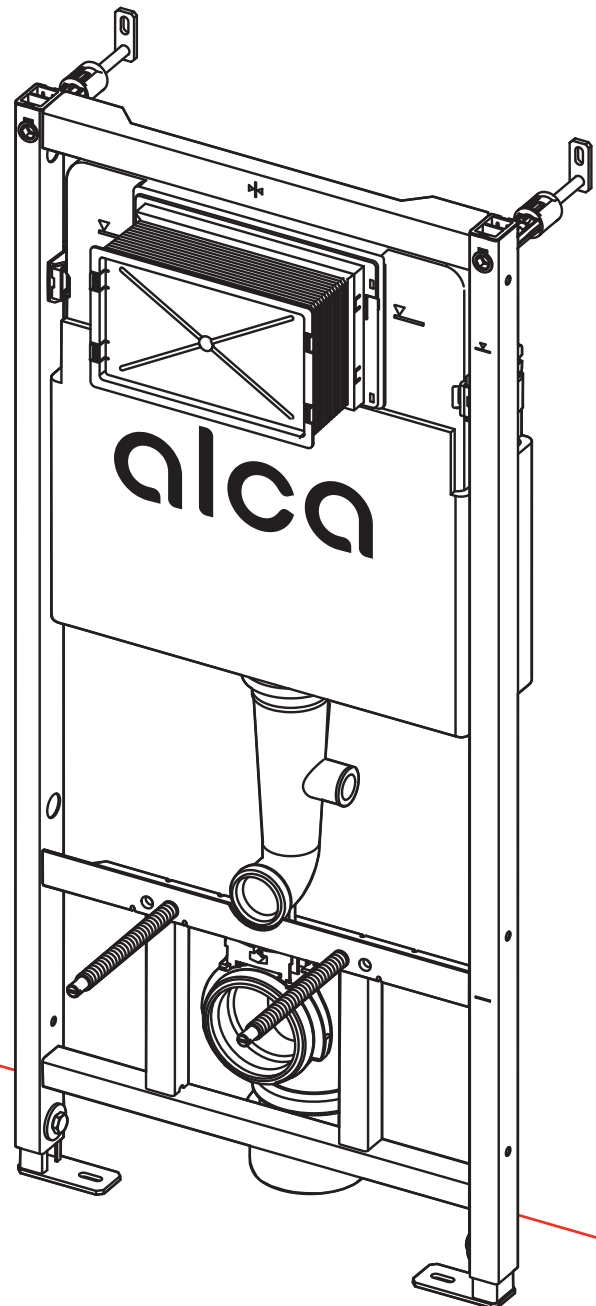

Every system needs to be checked and serviced from time to time so that its functionality is flawless. It is the same with the concealed cistern. Whether it is the right volume of water for flushing, ensuring that the concealed cistern does not leak or correct water filling.

In this service manual, you will find clearly described all the procedures that will ensure long-term trouble-free use of the Alca concealed cistern.

We recommend servicing the concealed cistern at least once a year.

1. Check the correct setting of the WC flush plate
2. Check the flushing mechanism
3. Check the correct attachment of the water supply hose to the concealed cistern
4. Check the inlet fill valve
5. Check the flushing valve
6. Check the toilet bowl

1. Check the correct setting of the WC flush plate

An incorrectly adjusted flush plate can cause leaking of the concealed cistern. If the buttons for a small or large flush do not have sufficient clearance, the flushing mechanism is permanently pressed and the concealed cistern may leak. Correctly adjusted small and large buttons must have a clearance of 1–2 mm for free movement when pressed.

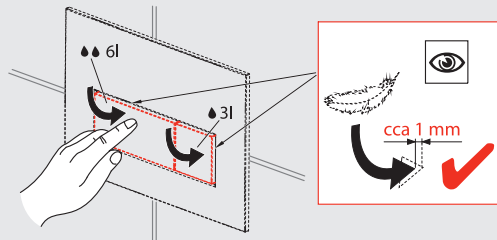

How to correctly set the Alca flush plate

1. Remove the flush plate. For THIN and FLAT flush plates, gently press your thumbs on the top half of the flush plate and tilt the bottom part away from the wall. The flush plate simply tilts out. For the flush plate from the Basic series, it is necessary to lift the entire flush plate from the bottom upwards and fold it from the top.

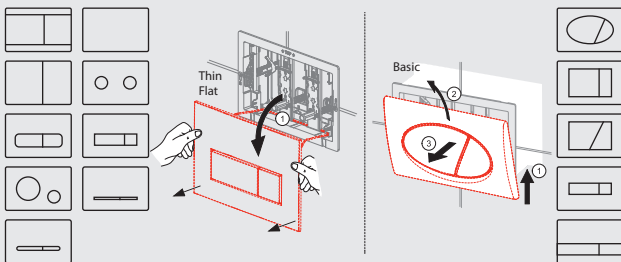

2. Set the appropriate distance of the screws that are used to adjust the correct clearance of each button. Use the cartoon template that you will find in the package of your flush plate.

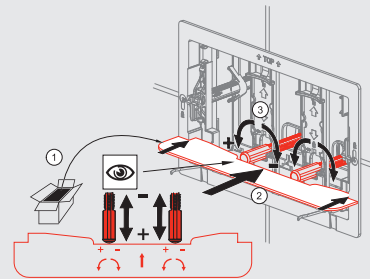

3. Checking the screw locks. Make sure that the locks used to secure the flush plate frame are locked in the bottom position, thereby fixing the position of the screws.

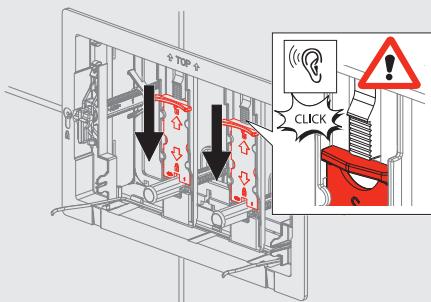

4. Put the flush plate back, check the compression clearance – it should be 1–2 mm.

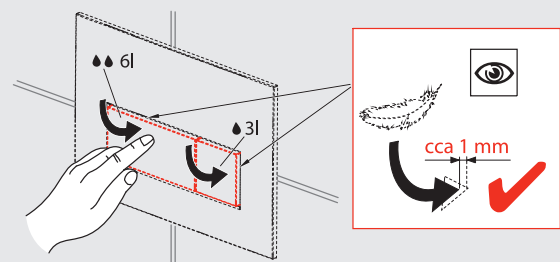

2. Check of the flushing mechanism

The flushing mechanism controls the flush valve, i.e. the flushing itself. It is located right behind the inner plate separating the flush plate from the concealed cistern.

How to correctly install the flushing mechanism

1. Tilt the WC flush plate from the WC system. For THIN and FLAT flush plates, gently press your thumbs on the top half of the flush plate and tilt the bottom part away from the wall. The flush plate simply tilts out. For the flush plates from the Basic series, it is necessary to lift the flush plate from the bottom upwards and click it out with light pressure.

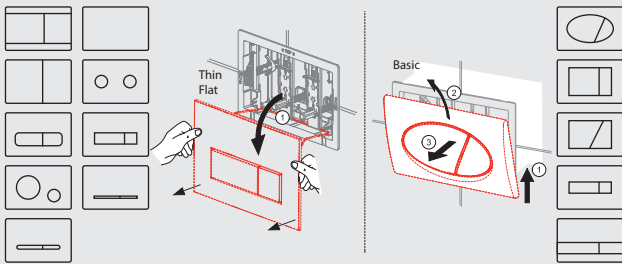

2. Remove the complete flush plate from the concealed cistern. First of all release the locks used to fasten the flush plate frame. Then use the side clamps to release the flush plate itself and remove it.

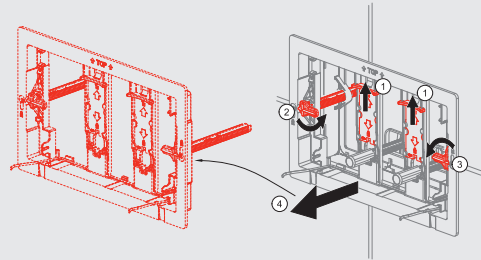

3 Remove the inner plate separating the flush plate from the concealed cistern. You can remove the inner plate by clicking out the grips on the upper edge of the plate.

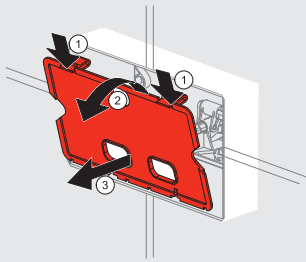

4. If your concealed cistern is equipped with a toilet tablet dispenser, remove it.

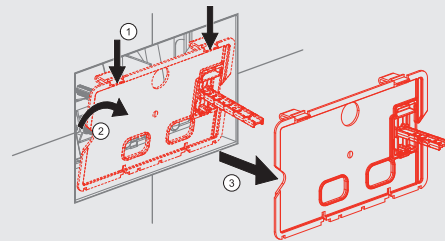

5. Check that the flushing mechanism is properly placed in the cistern and is securely fastened. The mechanism must fit into the two openings on the rear wall of the cistern. You should hear a click when it is inserted into the front part of the cistern. Check the correct fitting of the flush valve rod in the flushing mechanism. Once the mechanism is properly placed, attach the flushing mechanism rod from the fill valve.

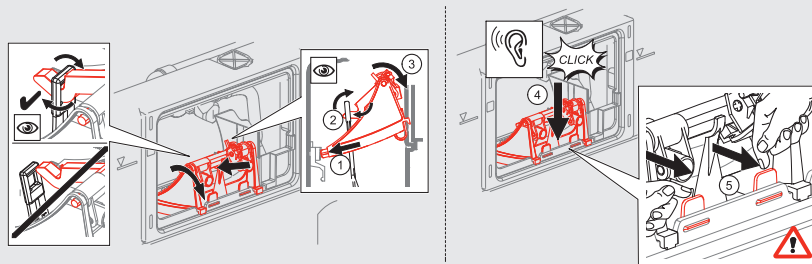

6. Check the functionality of the small flush lock. When the small flush button is pressed, the lock must swing to the left and hit the center reinforcement.

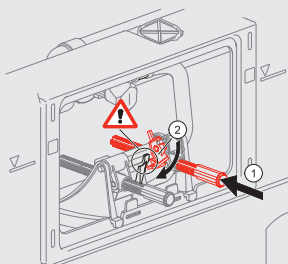

7. If the mechanism is damaged in any way, it must be replaced with a new one. You can get it from your local plumber.

3. Check the correct attachment of the water supply hose to the concealed cistern

The water supply hose must be fastened, otherwise it may limit movement of the flush valve float. Check its correct attachment.

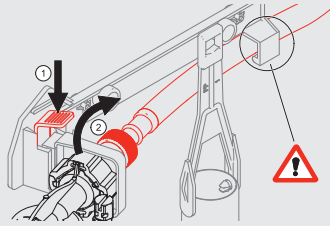

How to properly fasten the water supply hose

1. Tilt the WC flush plate from the WC system. For THIN and FLAT flush plates, gently press your thumbs on the top half of the flush plate and tilt the bottom part away from the wall. The flush plate simply tilts out. For the flush plates from the Basic series, it is necessary to lift the flush plate from the bottom upwards and click it out with light pressure.

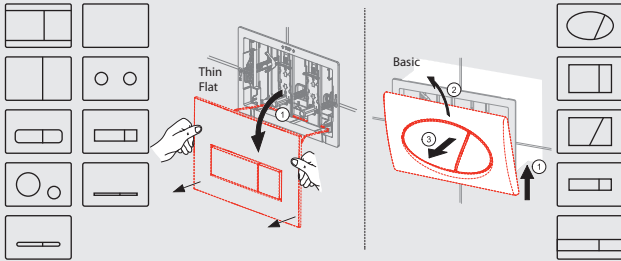

2. Remove the complete flush plate from the concealed cistern. First of all release the locks used to fasten the flush plate frame. Then use the side clamps to release the flush plate itself and remove it.

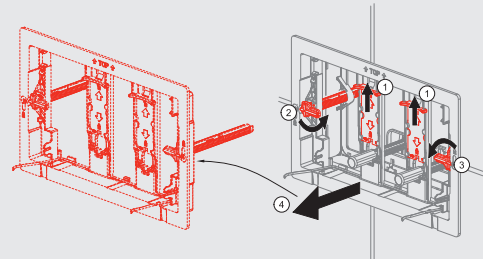

3. Remove the inner plate separating the flush plate from the concealed cistern. You can remove the inner plate by clicking out the grips on the upper edge of the plate.

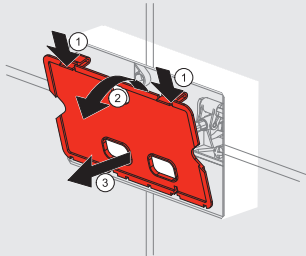

4. If your concealed cistern is equipped with a toilet tablet dispenser, remove it.

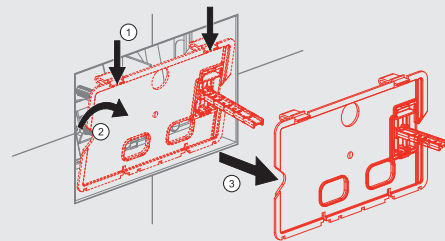

5. Remove the flushing mechanism, which controls the flush valve rod.

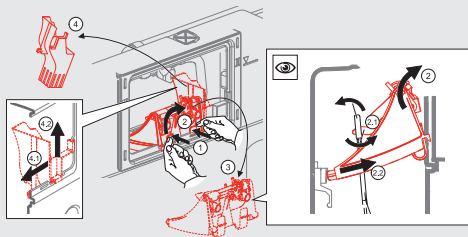

6. Check the attachment of the water supply hose – the hose must be firmly attached to the hose holder.

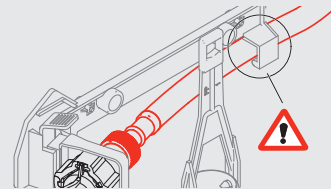

7. Reassemble all concealed cistern components. Start with the flush valve rod (be sure to attach it to the flush valve mechanism), then reassemble the inner plate (you should hear a click) and reinstall the flush plate.

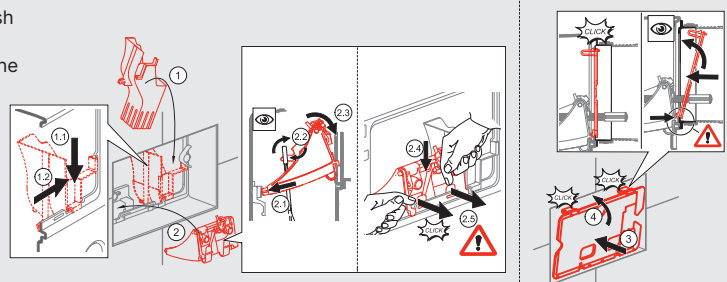

4. Check of the inlet fill valve

The function of the filling valve is to fill the cistern with the correct volume of water after each flush. If the flush valve has a fallen float, is incorrectly placed, or is damaged, water is constantly being filled into the cistern and then it overflows into the bowl.

Checking the fill valve

1. Tilt the WC flush plate from the WC system. For THIN and FLAT flush plates, gently press your thumbs on the top half of the flush plate and tilt the bottom part away from the wall. The flush plate simply tilts out. For the flush plates from the Basic series, it is necessary to lift the flush plate from the bottom upwards and click it out with light pressure.

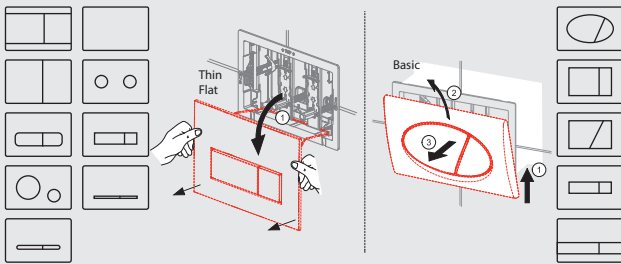

2. Remove the complete flush plate from the concealed cistern. First of all release the locks used to fasten the flush plate frame. Then use the side clamps to release the flush plate itself and remove it.

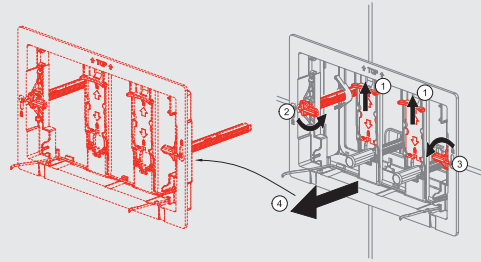

3 Remove the inner plate separating the flush plate from the concealed cistern. You can remove the inner plate by clicking out the grips on the upper edge of the plate.

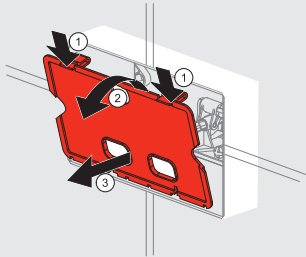

4. If your concealed cistern is equipped with a toilet tablet dispenser, remove it.

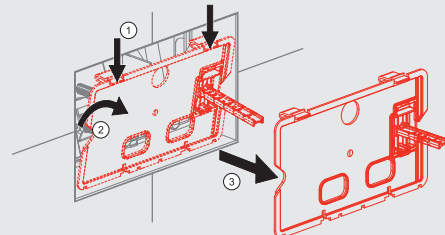

5. Remove the flushing mechanism, which controls the flush valve rod.

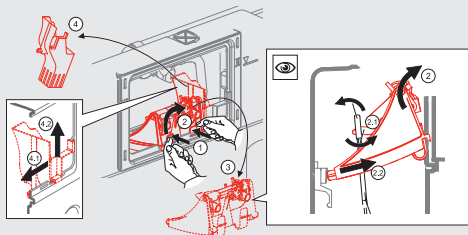

6. Checking the attachment of the fill valve to the cistern. The float must be attached to the holder in the concealed cistern.

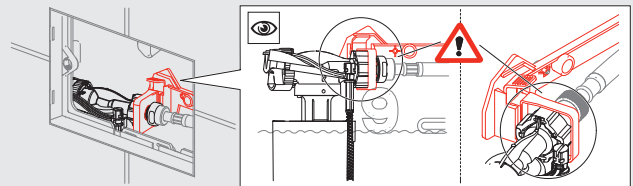

7. Checking and adjusting the float of the fill valve. When filling the cistern, the water must correspond to the line in the cistern (the line is located on the back of the cistern and a large number 9 is stamped on it). If the float is too high, the water overflows through the overflow pipe of the flush valve and water flows into the toilet bowl. The height of the water level could be adjusted by the red plastic screw on the fill valve.

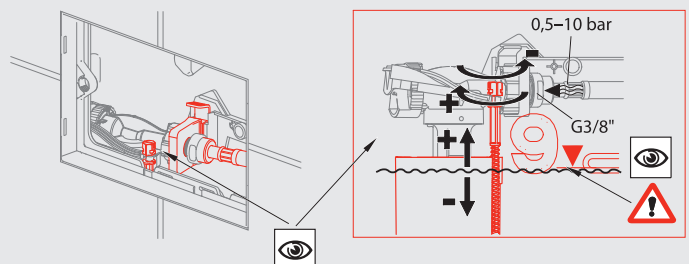

5. Check of the flushing valve

The flush valve serves to empty the cistern. Therefore, fitting the flush valve correctly and checking its tightness is essential for a proper functioning and leak-free toilet. It is also necessary to check the impurities in the toilet cistern, which can affect the tightness of the flush valve.

How to properly fix the flush valve

1. Tilt the WC flush plate from the WC system. For THIN and FLAT flush plates, gently press your thumbs on the top half of the flush plate and tilt the bottom part away from the wall. The flush plate simply tilts out. For the flush plates from the Basic series, it is necessary to lift the flush plate from the bottom upwards and click it out with light pressure.

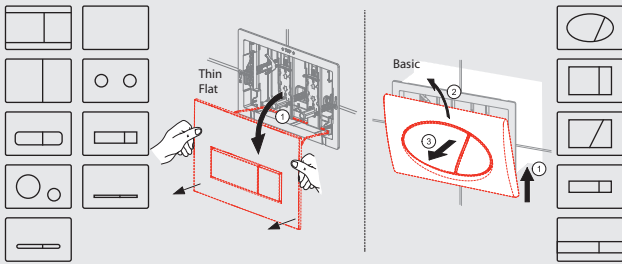

2. Remove the complete flush plate from the concealed cistern. First of all release the locks used to fasten the flush plate frame. Then use the side clamps to release the flush plate itself and remove it.

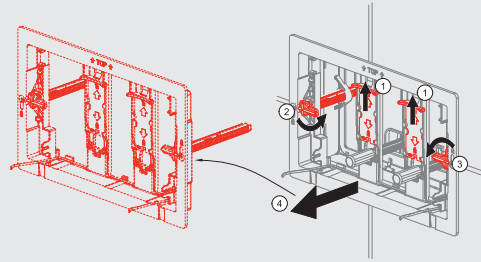

3 Remove the inner plate separating the flush plate from the concealed cistern. You can remove the inner plate by clicking out the grips on the upper edge of the plate.

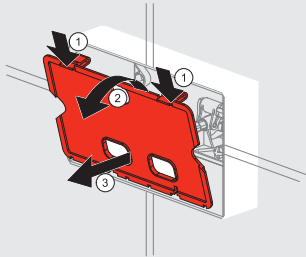

4. If your concealed cistern is equipped with a toilet tablet dispenser, remove it.

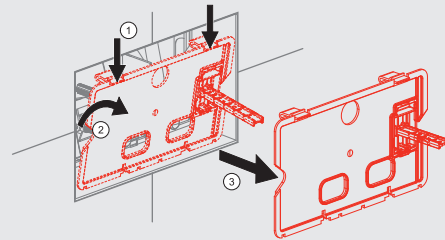

5. Remove the flushing mechanism, which controls the flush valve rod.

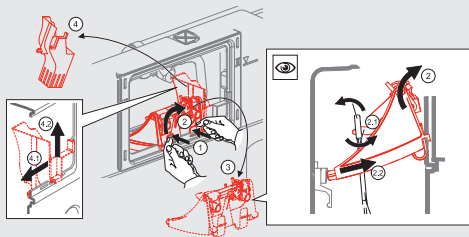

6. Turn off the water supply to the concealed cistern using an angle valve.

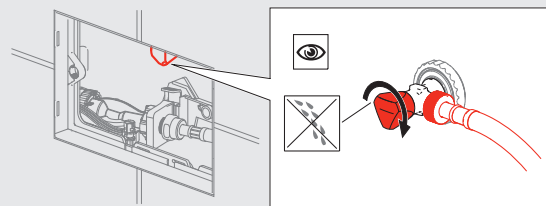

7. Disconnect and remove the fill valve. This will make the manipulation with the flush valve easier.

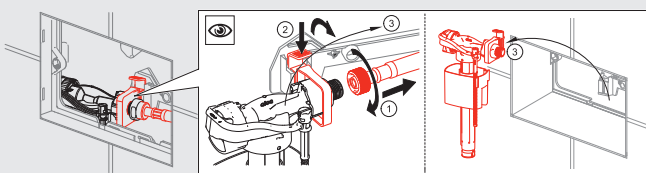

8. Remove the flush valve and empty all the water from the cistern. You can remove the flush valve by simply pulling it upwards.

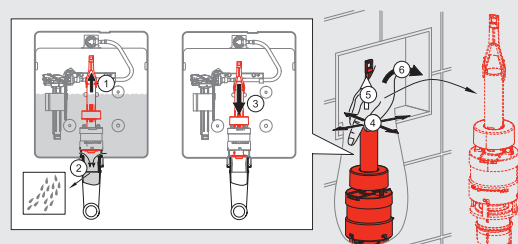

9. Remove impurities from the bottom of the cistern. Spray the cistern using the water hose disconnected from the fill valve

11. If the valve is mechanically damaged in any way, we recommend replacement for a new one. Contact your nearest plumbing supplier.

10. Sealing inspection. If the sealing is damaged in any way, contact your nearest plumbing supplier. The sealing must be replaced.

12. Put the valve back in place. Lubricate the outlet seal with liquid soap before reinstalling in the cistern. It must click into the neck the elbow cistern.

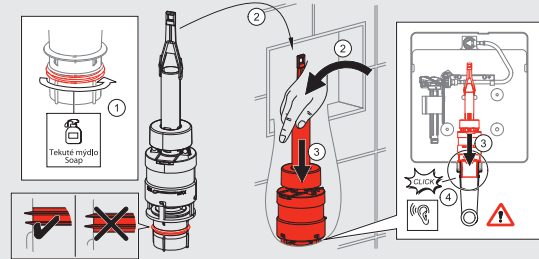

6. Check of the toilet bowl

Sometimes the flow itself is not caused by the concealed cistern, but directly by the WC bowl. Some toilet bowls have an inner hollow space in their upper edge, that enables creating water vortex in the bowl needed for rinsing. A larger volume of water may settle in this hollow space, which can flow out for several tens of minutes with a weak stream of water.

How to identify a problem with the toilet bowl

1. Tilt the WC flush plate from the WC system. For THIN and FLAT flush plates, gently press your thumbs on the top half of the flush plate and tilt the bottom part away from the wall. The flush plate simply tilts out. For the flush plates from the Basic series, it is necessary to lift the flush plate from the bottom upwards and click it out with light pressure.

2. Remove the complete flush plate from the concealed cistern. First of all release the locks used to fasten the flush plate frame. Then use the side clamps to release the flush plate itself and remove it.

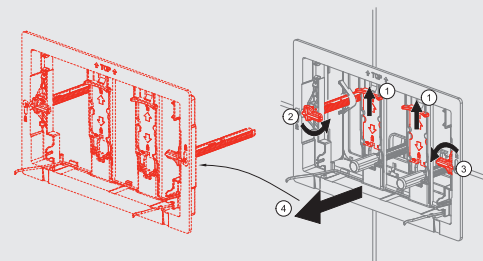
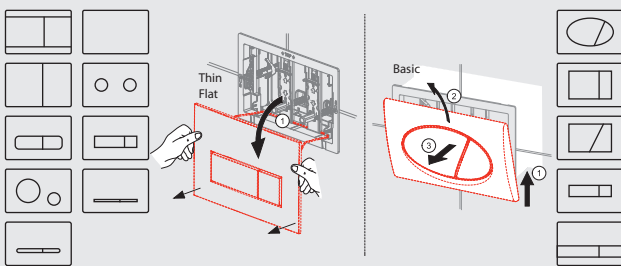

3 Remove the inner plate separating the flush plate from the concealed cistern. You can remove the inner plate by clicking out the grips on the upper edge of the plate.

4. If your concealed cistern is equipped with a toilet tablet dispenser, remove it.

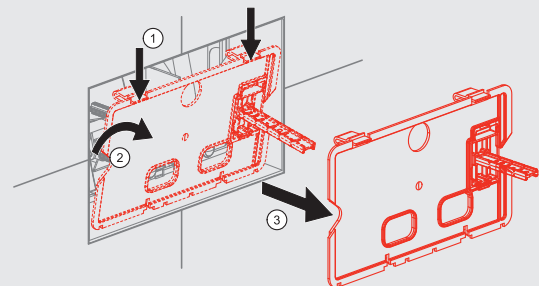
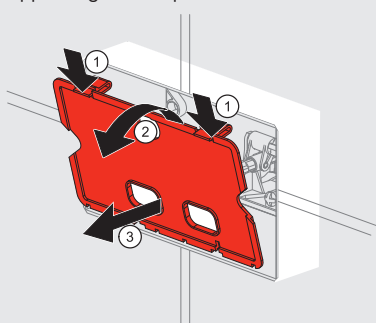

5. Remove the flushing mechanism, which controls the flush valve rod.

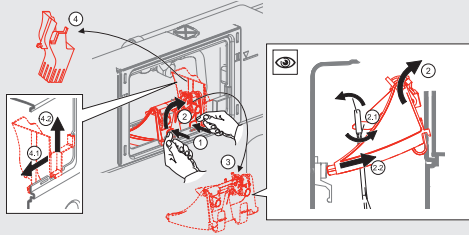

6. Turn off the water supply to the concealed cistern using an angle valve.

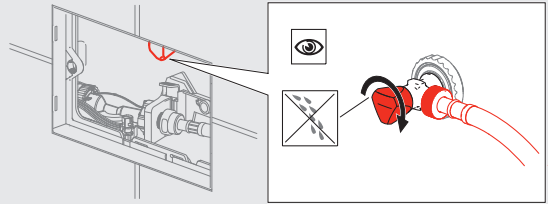

7. Disconnect and remove the fill valve.

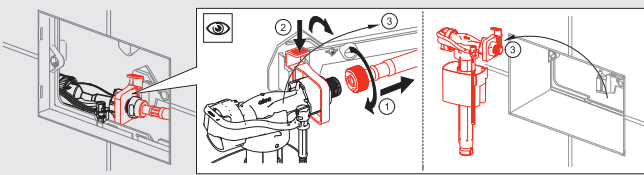

8. When the cistern is fully filled, flush and remove the flush valve from the cistern to completely empty the cistern. You can remove the flush valve.

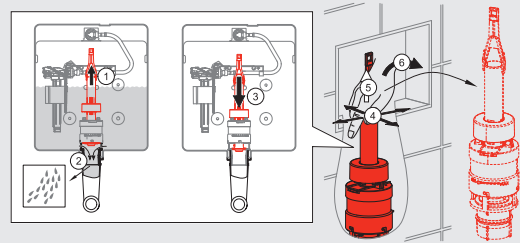

9. Long-term leakage along the back wall of the toilet bowl in a small trickle when there is no water in the cistern, is a defect of the toilet bowl (excessive inner hollow and wrong slope).

7. Lack of water to flush the toilet

For some toilet bowls, the standard water volume of 6 liters is insufficient for a large flush. For that reason, our WC system can be set to a larger flushing water volume by adjusting the flush valve.

How to increase the water volume for a large flush

1. Tilt the WC flush plate from the WC system. For THIN and FLAT flush plates, gently press your thumbs on the top half of the flush plate and tilt the bottom part away from the wall. The flush plate simply tilts out. For the flush plates from the Basic series, it is necessary to lift the flush plate from the bottom upwards and click it out with light pressure.

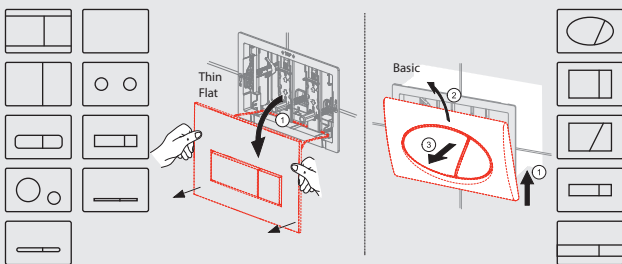

2. Remove the complete flush plate from the concealed cistern. First of all release the locks used to fasten the flush plate frame. Then use the side clamps to release the flush plate itself and remove it.

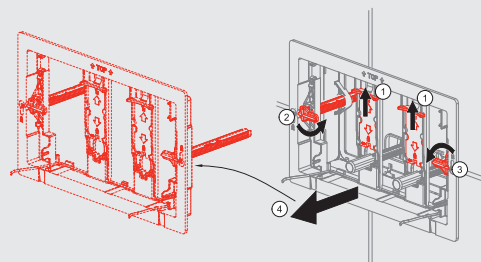

3 Remove the inner plate separating the flush plate from the concealed cistern. You can remove the inner plate by clicking out the grips on the upper edge of the plate.

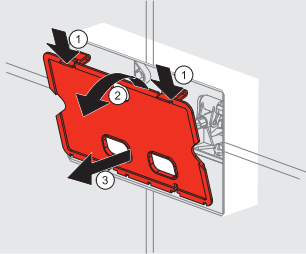

4. If your concealed cistern is equipped with a toilet tablet dispenser, remove it.

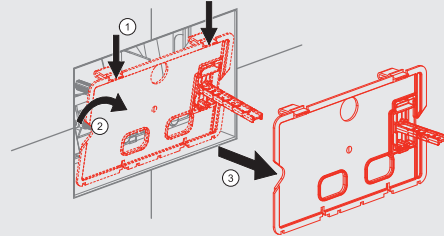

5. Remove the flushing mechanism, which controls the flush valve rod.

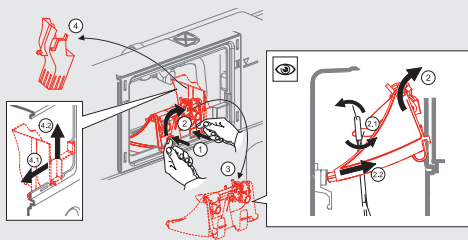

6. Turn off the water supply to the concealed cistern using an angle valve.

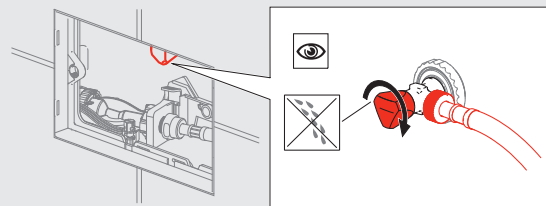

7. Disconnect and remove the fill valve. This will make the manipulation with the flush valve easier.

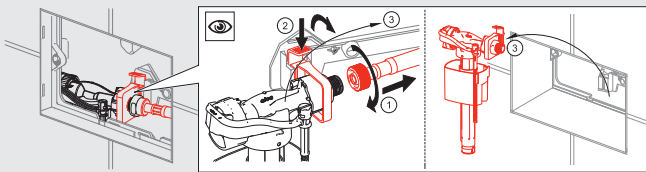

8. Remove the flush valve and empty all the water from the cistern. You can remove the flush valve by simply pulling it upwards.

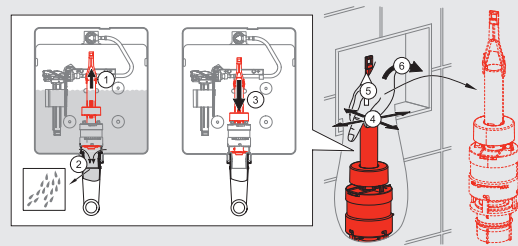

9. Increasing the flushing water volume on the flush valve.

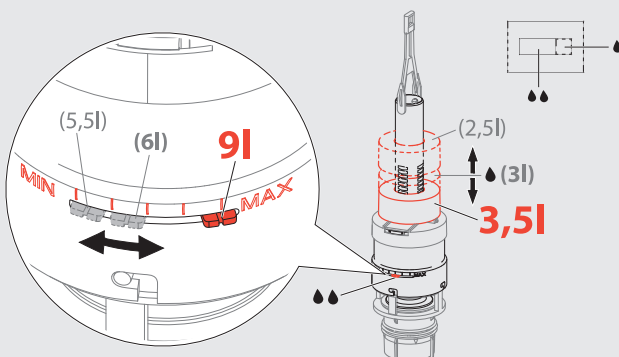

Have you got a problem with your concealed cistern and you are not able to solve it

If the toilet is still leaking, contact a plumber.