

# alca

Shower  
drains



[www.alcadrain.com](http://www.alcadrain.com)

# Content

## 12-25

### Stainless steel shower drains Alca

Brings revolutionary solutions both in cleaning and in water flow rate.



## 22-25

### Shower drains with two-sided grid

Shower drain, two-sided grid and trap, all in one package.

You already know the traditional stainless steel shower drains as "Fit and Go", now also available in plastic version with two-sided grid (APZ19, APZ19BLACK, APZ20).



## 8-11

### Grids for shower drains

They are made of top quality materials, that accentuate the innovative modern design, which comes out from playfulness and variety.



## 26-35

### Plastic shower drains Alca

Easy to clean and made of materials that resist low temperatures and chemicals. These popular plastic shower drains are now also available with two-sided grid.



Together we create  
a place where  
you can recharge  
the energy again

### Lets make it simple

We have launched a shower drain configurator on our website, which will significantly facilitate orientation in a wide portfolio of Alca shower drains. You are able to quickly find a shower drain suitable for your bathroom by selecting the items in the configurator according to your preferences.



Online configurator  
[www.alcadrain.com/selection-guide](http://www.alcadrain.com/selection-guide)



<b>Alca shower drains advantages</b> . . . . .	6-7
<b>Grids Alca</b> . . . . .	8-11
<b>Linear shower drains Alca</b> . . . . .	12-35
Shower drains APZ1, APZ4, APZ1BLACK, APZ6, APZ16 . . . . .	12-17
Shower drain APZ15 . . . . .	18-19
Waste system APZ5 . . . . .	20-21
Shower drain APZ13, APZ23 . . . . .	22-25
Plastic linear shower drains . . . . .	26-35
Plastic linear shower drains with stainless steel edge . . . . .	34-35
<b>Stainless steel floor drains</b> . . . . .	36-37
<b>Specifications of Alca shower drains</b> . . . . .	38-39
<b>Shower drains Alca overview</b> . . . . .	40-49
Stainless steel shower drains for perforated grids . . . . .	40
Stainless steel shower drains for full grids . . . . .	41
Stainless steel shower drain APZ13, APZ23 . . . . .	42-43
Waste system APZ5 and Antivandal system . . . . .	44
<b>Stainless steel floor drains overview</b> . . . . .	45
Plastic linear shower drains . . . . .	46-49
<b>Alca Group company</b> . . . . .	50-51

# 25 years of experience

For 25 years, we have been producing a complete assortment for drainage. That is a quarter of a century of development and improvement of production processes and the products themselves. That's why we can offer you high quality with time-tested pride and confidence, which in our products is naturally combined with timeless but also modern design. An extended warranty of 25 years for stainless steel shower drains is proof that we are truly convinced of the quality of our products.



**APZ1 + grid PURE**

Stainless steel shower drain  
with perforated grid

**25** year warranty

# Shower drain is the basis of modern bathroom

Bet it safe  
and choose a reliable  
shower drain Alca.

High flow rate  
of water up to  
68 l/min

Completely  
cleanable  
trap

Low  
installation  
height  
(55 mm)

Wide grid  
variations



### APZ16 Wall + grid DESIGN

Shower drain with an edge  
and fixed vertical flange to  
the wall with full grid

### APZ901M/1000

Stainless steel strip for sloping  
floors. Available in variants:  
left, right, two-sided  
**Order together with  
the shower drain**

**25** year warranty

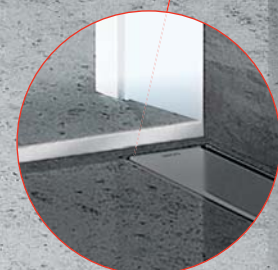

## GRIDS FOR LINEAR DRAINS

# Beauty has many forms



### APZ6 Professional + grid POSH

Stainless steel shower drain  
with an edge and full grid

**25** year warranty

## Grids for linear shower drains

	LINE stainless steel- matt	PURE stainless steel- matt	PURE BLACK black-matt	BUBLE stainless steel- matt	HOPE stainless steel- matt	DREAM stainless steel- matt	CUBE stainless steel- matt	CODE stainless steel- matt	ZIP stainless steel- matt	APZ9 stainless steel- matt	APZ10 stainless steel- matt	APZ10BLACK black-matt	APZ10BLACK- BRASS
PERFORATED GRIDS													
STAINLESS STEEL	APZ1 APZ101 APZ1001 APZ1101 APZ4 APZ104 APZ1004 APZ1104 APZ2001	APZ1 APZ101 APZ1001 APZ1101 APZ4 APZ104 APZ1004 APZ1104 APZ2001	APZ1BLACK	APZ1 APZ101 APZ1001 APZ1101 APZ4 APZ104 APZ1004 APZ1104 APZ2001 APZ11 APZ111	APZ1 APZ101 APZ1001 APZ1101 APZ4 APZ104 APZ1004 APZ1104 APZ2001	APZ1 APZ101 APZ1001 APZ1101 APZ4 APZ104 APZ1004 APZ1104 APZ2001	APZ1 APZ101 APZ1001 APZ1101 APZ4 APZ104 APZ1004 APZ1104 APZ2001	APZ13 APZ23	APZ13 APZ23				
PLASTIC	APZ12 APZ2012	APZ12 APZ2012		APZ12 APZ2012	APZ12 APZ2012	APZ12 APZ2012	APZ12 APZ2012			APZ9	APZ10 APZ30	APZ10BLACK	APZ10BLACK- BRASS

	GAP stainless steel- matt	STREAM stainless steel- matt	GL1200 glass-white	GL1204 glass-black	DESIGN stainless steel- matt	POSH stainless steel- matt	DESIGN-ANTIC bronze-antic	FLOOR TILE for embedding tiles	APZ15 for embedding tiles	OPTION DOUBLE APZ19/APZ20 stainless steel-matt/for embedding tiles	APZ19BLACK black-matt/for embedding tiles	APZ5-SHADE stainless steel- matt	APZ5-TWIN for embedding tiles	LIFE stainless steel- matt	TIME stainless steel- matt
PRISMATIC GRIDS															
STAINLESS STEEL	APZ6 APZ1006 APZ1106 APZ16 APZ116 APZ1016 APZ1116	APZ13 APZ23	APZ6 APZ106 APZ1006 APZ1106 APZ16 APZ116 APZ1016 APZ1116	APZ6 APZ106 APZ1006 APZ1106 APZ16 APZ116 APZ1016 APZ1116	DESIGN APZ6 APZ106 APZ1006 APZ1106 APZ16 APZ116 APZ1016 APZ1116	APZ6 APZ106 APZ1006 APZ1106 APZ16 APZ116 APZ1016 APZ1116	APZ6 APZ106 APZ1006 APZ1106 APZ16 APZ116 APZ1016 APZ1116	FLOOR APZ6 APZ106 APZ1006 APZ1106 APZ16 APZ116 APZ1016 APZ1116	APZ15 APZ115	DOUBLE APZ13 Fit and Go APZ23 Fit and Go Wall	new APZ19BLACK	APZ5-SHADE	APZ5-TWIN	ARZ1	
PLASTIC								TILE APZ12 APZ2012		OPTION APZ12 APZ2012  APZ19 APZ20	APZ19BLACK				

## Almost infinite palette of possibilities

### Wide range of grids

Whether you let the grid stand out or whether you are a lover of minimalism and want the grid to be optically linked to the floor tiles, it's up to you. We offer a wide selection of interesting grids in various designs and materials. Let yourself be inspired.

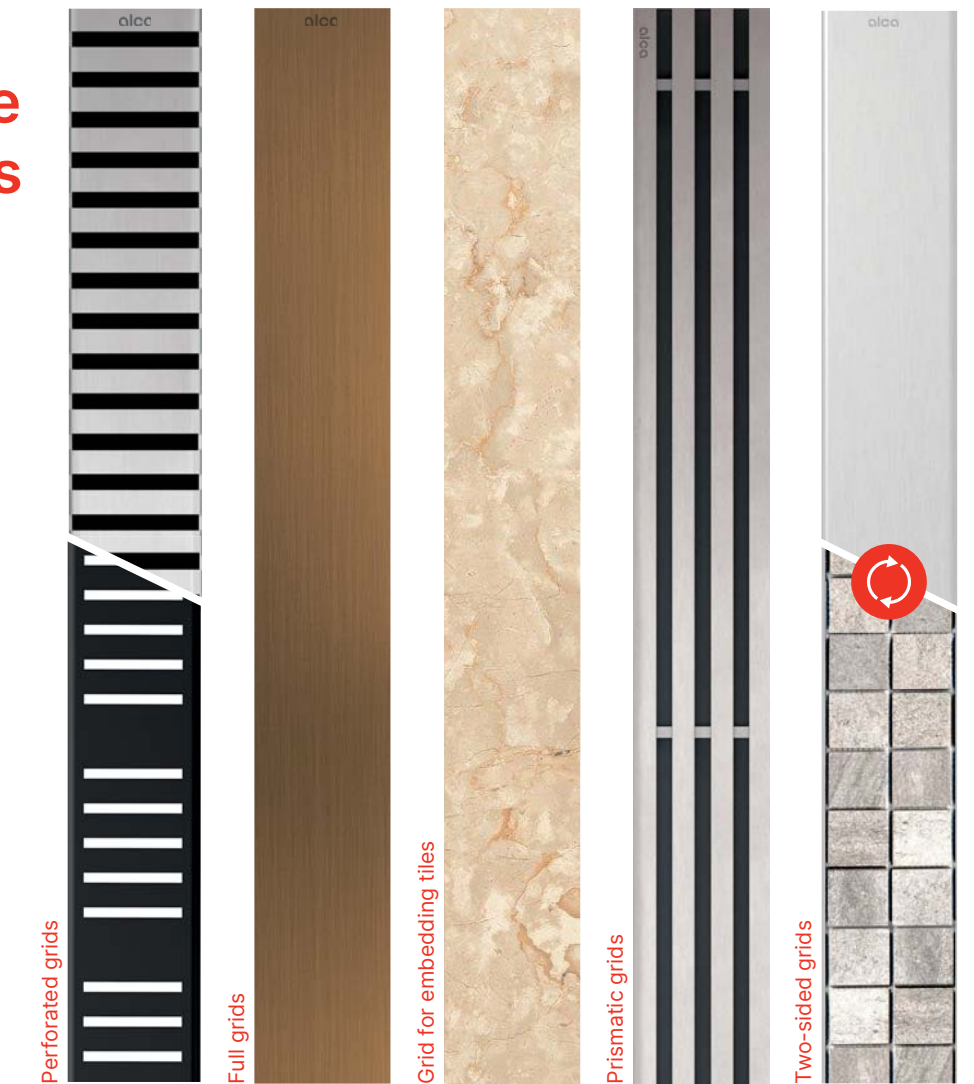

### Perforated grids

Perforated grids Alca are based on playful variations of geometric shapes. So you can easily choose the right one according to your taste. They are available in high gloss or brushed matt. The standard version is made of stainless steel with an option of even higher grade for aggressive environments such as swimming pools.

### Full grids

The base of the grid consists of a U-profile made of stainless steel. On this U-Profile we can attach a solid plate of stainless steel, tempered glass or brass. With this wide range of surface options available, the full Alca grid becomes a jewel of your bathroom.

### Grids for embedding tiles

Stainless steel grids are finished with a rough surface, which is designed for easy gluing tiles or waterproof wood.

### Grid without edge for embedding tiles

We introduce the stainless steel grid without edge for embedding tiles APZ15. This grid then becomes part of the tiling and fully merges with the rest of the bathroom.

### Prismatic grid

This solid stainless steel prismatic grid offers a novel alternative. The distinctive design stands out from the standard to become a true feature of your bathroom.

### Two-sided grids

The grid gives the choice – either full stainless steel grid or by simply rotating the grid for embedding tiles. You can make the final decision even after installation of the shower drain without any construction modifications.

SHOWER DRAIN  
FOR A PERFORATED GRID

# Favorite shower drain



## APZ1 + grid LINE

Stainless steel shower drain  
with perforated grid

Variants of stainless steel shower  
drains for perforated grids

APZ1  
APZ101 Low  
APZ1001  
APZ1101 Low  
APZ4 Flexible  
APZ104 Flexible Low  
APZ1004 Flexible  
APZ1104 Flexible Low  
APZ2001

→ see p. 40

**60** liters/min

**25** year warranty



Online configurator  
[www.alcadrain.com/selection-guide](http://www.alcadrain.com/selection-guide)

alca

## Reliable choice meets all your requirements

### Shower drain APZ1 for perforated grids

Our designers have developed shower drains Alca in various types, allowing a perfect fit into diverse bathroom styles. Delivering even more individuality to its owners. Stainless steel shower drain Alca uses two drain outlet chambers with removable strainers. The lowest installation height for Alca drains is from 55 mm (APZ101 Low) to 85 mm (APZ1). Height 55 mm is suitable for house renovations. Height 85 mm is ideal for new buildings.

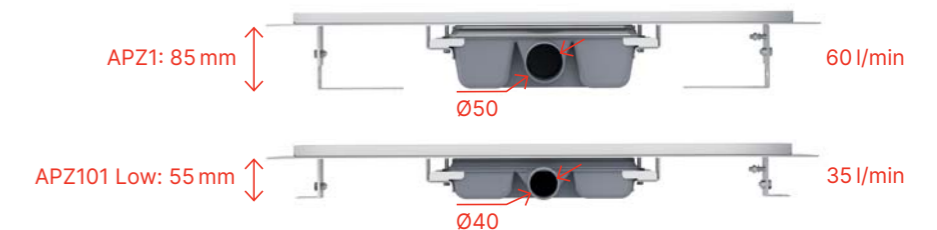
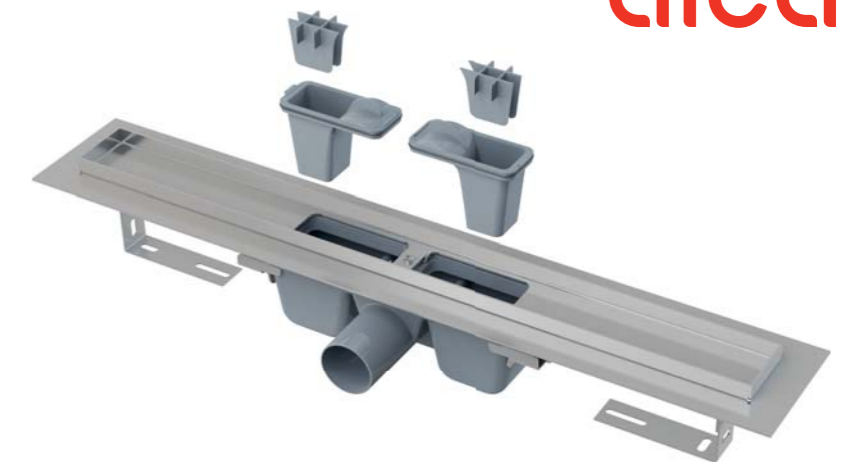

Perforated grid example:

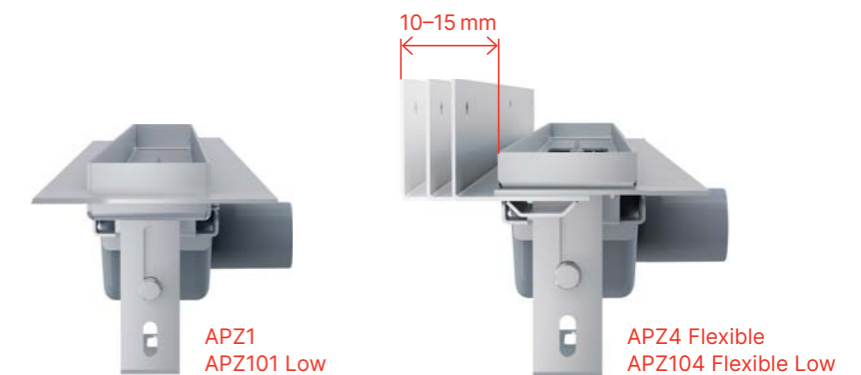

### Variant to the wall APZ4 Flexible

Linear drains APZ4, APZ104 Low, APZ1004 and APZ1104 Low are designed to be installed directly to the wall of the shower enclosure. The vertical flange can be adjusted to suit wall tiles 6-12 mm in thickness. This eliminates the need to compensate for any differences in tile thickness with adhesive. Unlike other shower drains, the Flexible drain is attached to the wall using a vertical flange. It is then covered with a waterproofing tape and wall tiles. This ensures a higher grade of waterproofing. Grading the floor towards the wall is also easier.



### APZ4 Flexible + grid BUBLE

Stainless steel shower drain with adjustable flange to the wall, with a perforated grid

SHOWER DRAIN  
FOR PERFORATED GRID BLACK-MATT

# Pure black



## APZ1BLACK + grid PURE BLACK

Stainless steel shower drain  
in black-matt finish  
with perforated grid

### Variants of stainless steel shower drains black-matt

APZ1BLACK  
APZ101BLACK Low

→ see p. 40



Online configurator  
[www.alcadrain.com/selection-guide](http://www.alcadrain.com/selection-guide)

alca

## Black-matt will highlight the new look of your bathroom



### Shower drain APZ1BLACK in black-matt finish

Our linear shower drains APZ1  
and APZ101 are now available  
in the modern black-matt finish,  
supplemented by PURE BLACK grid.  
We always think about details, that  
is why the odour trap is black as well.  
It merges fully with the grid  
and the shower drain.

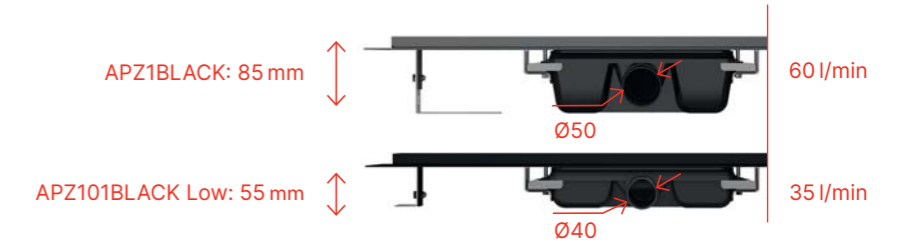

### Comprehensive black-matt program

Black-matt program includes  
a number of other products:

- Flush plates  
(M278, M578, M678, M778, M778-5, M1878,  
M1878-7, M1978, M1978-7, FUN-BLACK,  
TURN-BLACK, MOON-BLACK)
- Bath traps  
(A55BLACK, A507BLACK, A564BLACK)
- Shower traps (A465BLACK-50, A49BLACK)
- Wash-basin traps (A400BLACK, A4320BLACK,  
A4000BLACK)
- Wash-basin wastes  
(A392BLACK, A396BLACK)
- Angle valves  
(ARV001-BLACK, ARV003-BLACK)
- Plastic shower drains  
(APZ10BLACK, APZ19BLACK)
- Floor drains (APV31BLACK, APV32BLACK)

[www.alcadrain.com/en/program-black-matt](http://www.alcadrain.com/en/program-black-matt)



# Endless possibilities

↑  
**Stainless steel strip for sloping floors**

Available in variants: left, right, two-sided.

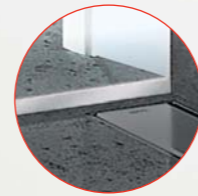

**APZ6 Professional + grid GL1200 + APZ903M/1200**

Stainless steel shower drain with full glass grid and stainless steel strip for sloped floor

**Variants of stainless steel shower drains for full grids**

- APZ6 Professional
- APZ106 Professional Low
- APZ1006 Professional
- APZ1106 Professional Low
- APZ16 Wall
- APZ116 Wall Low
- APZ1016 Wall
- APZ1116 Wall Low

→ see p. 41

**25** year warranty

 Online configurator  
[www.alcadrain.com/selection-guide](http://www.alcadrain.com/selection-guide)

## Choice of 7 grids

### Shower drain APZ6 for full grids

As an alternative to perforated grids we offer a range of grid designs made of glass, massive prismatic grid or the popular grid for embedding tiles. They are designed for shower drains APZ6 or APZ16 Wall with fixed vertical flange to the wall.

Full grid



Prismatic grid



Glass grid



Grid for embedding tiles

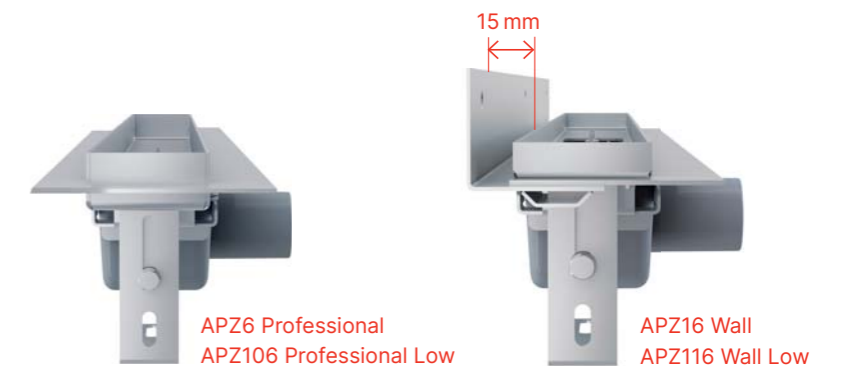
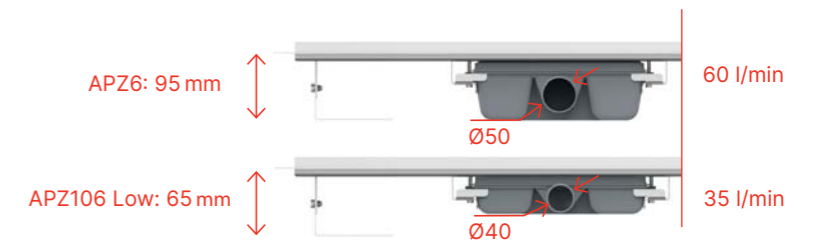

### A variant to the wall APZ16 Wall

Linear shower drain APZ16 Wall combines the benefits of the linear drain APZ6 for full grids and vertical fixed flange to the wall. The vertical flange with a fixed distance of 15 mm from the shower drain body edge can suit wall tiles 6–12 mm in thickness.

←  
**APZ16 Wall + grid FLOOR**

Stainless steel shower drain with fixed flange to the wall, with a grid for embedding tiles



SHOWER DRAIN WITHOUT EDGE  
WITH GRID FOR EMBEDDING TILES

# Merges into one surface



## APZ15 Marble

Shower drain without edge  
with grid for embedding tiles

### Variants of stainless steel shower drains without edge

APZ15 Marble  
APZ115 Marble Low

→ see p. 41

**25** year warranty



Online configurator  
[www.alcadrain.com/selection-guide](http://www.alcadrain.com/selection-guide)

alca

## Both shower drain and grid without edge

### Shower drain without edge APZ15 and grid for embedding tiles

The new generation of stainless steel shower drains APZ15 is produced especially for design focused installations. The water is drained by two slots in the floor of the bathroom that hides the stainless steel shower drain. The overall finish is not interrupted by the edge of the grid.

### Unlimited paving height

Thanks to the fact that the shower drain and grid have no edges, you are not limited in any way when choosing tiles. You can use the surface of any height, from ultra-thin large-format tiles to robust natural stone slabs.

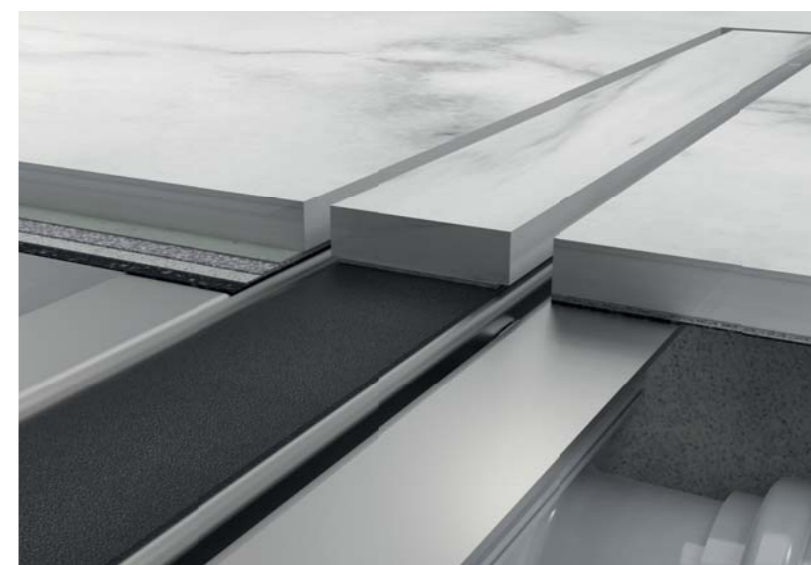
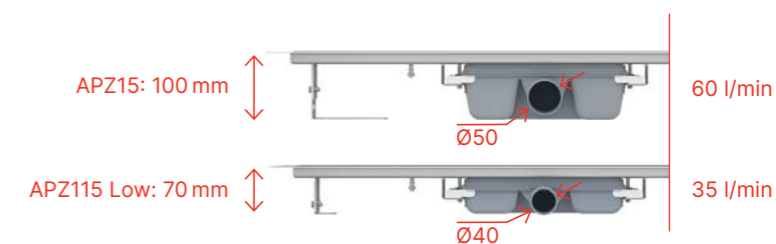

### Pure design lines

We think that the great inventions may not be pompous. All the sophisticated and complex technical solutions remain hidden and all what is visible is simple and beautiful. Grid for embedding tiles is brilliant in its simplicity.

### Possibility of atypical lengths

Dimensions up to 2200 mm made in one piece.



all in package



WASTE SYSTEM  
FOR INSTALLATION IN WALL

# Pure lines

## APZ5 Spa + cover SHADE

Stainless steel waste system  
for installation in wall with full  
cover.

Installation depth: 64 mm

### Variants of waste systems

APZ5-SHADE Spa  
APZ5-TWIN Spa

→ see p. 44

**25** year warranty



Online configurator  
[www.alcadrain.com/selection-guide](http://www.alcadrain.com/selection-guide)

alca

## It illuminates the space or hides perfectly

### Waste system for installation in wall

The system is particularly suitable  
for areas with greater frequency of  
use, such as swimming pools, spas  
and wellness centers. The cover panel  
can be chosen in a gloss or matt finish,  
or it can be embedded with tiles that  
blend perfectly with your shower.  
Water flows into the drain only between  
the edge of the floor tiles and the cover  
of the drain system.

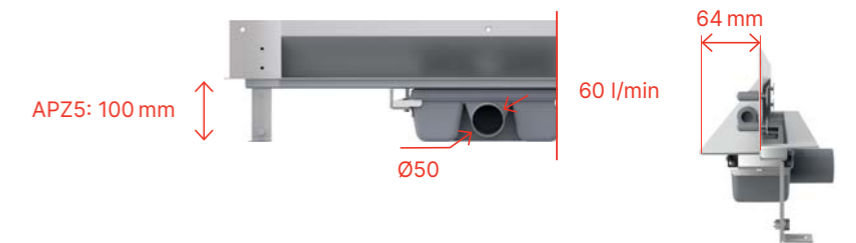

↓ APZ5-SHADE Spa  
Cover stainless steel-mat



↓ APZ5-TWIN Spa  
Cover for embedding tiles

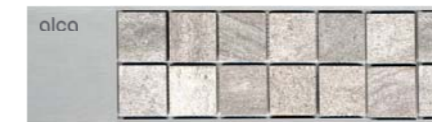

### Drain ALCA LIGHT with lighting

ALCA LIGHT is a LED illuminated waste system  
APZ5 Spa. It brings pleasant subdued lighting  
that enhances the function and design  
of your bathroom.

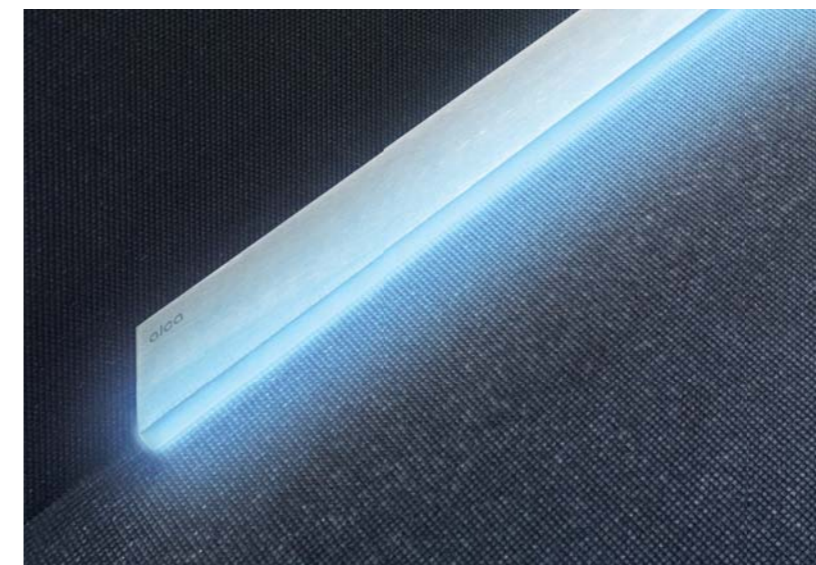

WHITE  
AEZ120



GREEN  
AEZ122



RED  
AEZ123



RAINBOW (RGB)  
AEZ124

Available in colors: blue, white, green, red and rainbow

# Fit and Go



## APZ13-DOUBLE9 Fit and Go + grid DOUBLE

Stainless steel shower drain  
with two-sided grid

**25** year warranty

Variants of shower drains  
APZ13-DOUBLE9 Fit and Go  
APZ13 Modular  
APZ23-DOUBLE9 Fit and Go

→ see p. 42-43

Online configurator  
[www.alcadrain.com/selection-guide](http://www.alcadrain.com/selection-guide)

## One grid offering two possibilities of use

### Shower drain APZ13-DOUBLE9 Fit and Go

Two-sided grid DOUBLE offers the choice of grid design even after the shower drain installation – you can choose between full stainless steel grid and grid for embedding tiles.

Two-sided grid DOUBLE



all in package



APZ13-DOUBLE9-550,  
650, 750, 850, 950

Extra low trap:  
APZ13-DOUBLE6:  
54 mm

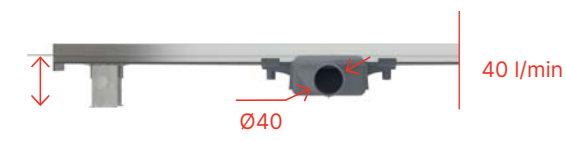

Low trap:  
APZ13-DOUBLE9:  
81 mm

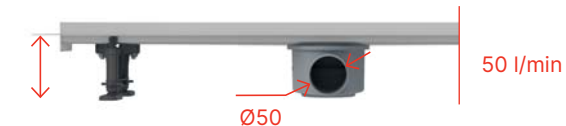

APZ13-DOUBLE6  
Fit and Go



APZ13-DOUBLE9  
Fit and Go



APZ23-DOUBLE9  
Fit and Go Wall

### A variant to the wall APZ23- DOUBLE9 Fit and Go Wall

The version of the shower drain Fit and Go with a fixed flange to the wall is attractive in design as well it enables sloping to the floor much easier.

all in package



### APZ23-DOUBLE9 Fit and Go Wall + grid DOUBLE

Stainless steel shower drain to the wall  
with two-sided grid



alca

alca



### Adjustable drain height

Individually adjustable anchor legs ensure trouble free installation, even when faced with significant unevenness of the underlying surface.



### Combined odour traps

The new combined odour traps for shower drain APZ13 protect against the penetration of odours from the sewer even after drying of the water in the trap.

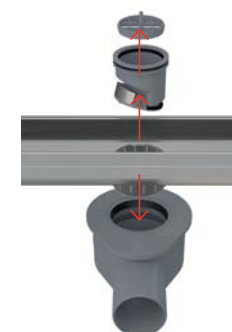

### Cleanable odour trap

The water odour trap is fitted with a screen that catches hair and other debris. Moreover, the screen is easily removable for trap cleaning without the use of chemicals. Removal of the screen permits the use of standard tools for clearing obstructed pipes.



### One piece construction with smooth finish

The body of each shower drain Alca is precisely rounded and surface finished using the latest technology designed, developed and built by Alca engineers. Thanks to this, the drains are very pleasant to touch and even enhance the pleasant experience of everyday showering. Form, finish and design enhance the users overall shower experience.

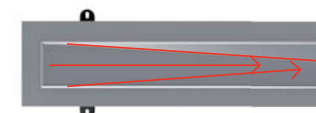

### Sloping inner gradient

We have introduced a gradient towards the outflow. This ensures maximum water flow rate and simplifies manual cleaning.



### Rotatable trap

Horizontal rotary trap provides unlimited possibilities for drain pipe connection in all directions. In addition, you do not need any other add-on fittings during the installation.

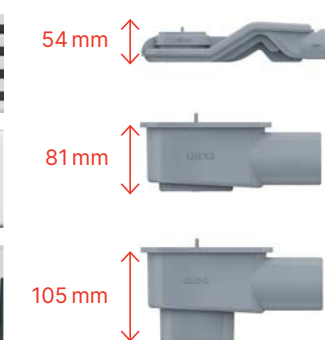
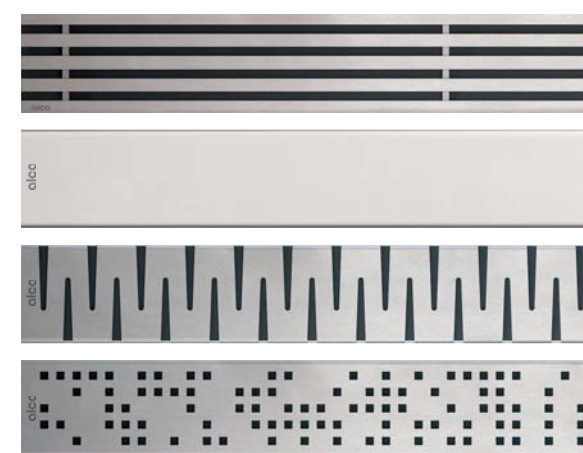

### Modular system

Introducing APZ13 Modular and APZ23 Modular Wall. The set consists of three basic components, which are the shower drain body, the odour trap and the grid. The shower drain body is made of one piece of stainless steel with in-built gradient, and you can choose three lengths – 750, 850 and 950 mm. The odour trap is rotatable and we offer three height variants. The main difference is in the construction height and the associated flow rate. The high odour trap with a flow rate 58 l/min is ideal for new buildings and wherever there is sufficient space. The low and extra-low profiles are determined for the places where it is needed to save space. You can choose from perforated grids or full grids, grids for embedding tiles and prismatic grids.

For more information see p. 43

## Real luxury is a possibility of choice

What is the real innovation? In principle it is something that will simplify the work and bring more comfort. We follow this motto exactly when developing the design and technology of our products.

We are pleased that thanks to this approach some of our products have already become bestsellers. We believe that the same fate awaits Fit and Go.

It has two main advantages. It is a comprehensive solution that includes everything you need. And as a plus leaves you the choice of the grid design until the last moment, to finish the appearance of your bathroom.

## PLASTIC LINEAR SHOWER DRAIN

# Two in one

new

### APZ19 Simple

Plastic shower drain with two-sided grid

Variants of plastic shower drains into the space

APZ19 Simple  
APZ19BLACK Simple  
APZ20 Simple  
APZ12 Optimal

→ see p. 48-49

6 year warranty

Online configurator  
[www.alcadrain.com/selection-guide](http://www.alcadrain.com/selection-guide)

alca

## Popular plastic shower drains now with two-sided grid

### Even more variants

The two-sided grid is now also included with these plastic shower drains:

**APZ19 Simple** (gray drain body + stainless steel two-sided grid). It replaces the APZ8 shower drain in the product range.

**APZ19BLACK Simple** (black drain body + black stainless steel two-sided grid).

**APZ20 Simple** (black drain body with stainless steel rim + stainless steel two-sided grid). It replaces the APZ18 shower drain in the product range.



all in package



APZ19 Simple

APZ19: 62 mm  $\updownarrow$  24 l/min  $\circ$ 40



### Other variants

#### Shower drain APZ19BLACK Simple

Basic model from the range of plastic shower drains in black design.



all in package

#### Shower drain APZ20 Simple

Basic model from the range of plastic shower drains with a stainless steel rim.



all in package

# Evergreen between shower drains



## APZ10 Simple

Plastic shower drain with perforated grid

**Variants of plastic shower drains into the space**

- APZ9 Simple
- APZ10 Simple
- APZ10BLACK
- APZ12 Optimal

→ see p. 46-49

**6** year warranty

Online configurator  
[www.alcadrain.com/selection-guide](http://www.alcadrain.com/selection-guide)

## Each space deserves a functional solution

### Plastic linear shower drains

They are made of highly durable plastic that resists frost and chemicals. All have a combined odour trap that protects against the penetration of odours from the sewer even after drying of the water in the trap or double compartment trap with high water flow rate (APZ12). For easy cleaning the trap can be completely disassembled up to the waste pipe.

### Shower drains APZ9 and APZ10 Simple

The basic model of plastic shower drain series features low building height of 62 mm which is particularly suitable for reconstructions and other builds, where there is a problem with a lack of space in the floor.



APZ9 Simple  
 APZ10 Simple



APZ9 / APZ10: 62 mm

28 l/min

all in package

Grid APZ9 Simple



Grid APZ10 Simple



### Shower drain APZ12 Optimal

Shower drain suitable as an economical solution to projects and other places where it is required to comply with different standards. It has a sloped inner gradient and a double compartment odour trap with a simple cleaning ability and flow rate up to 63 l/min. We guarantee you that your bathroom will not be flooded even if installing large format shower head with high water flow. We offer perforated grids, full grids or grids for embedding tiles or water-resistant wood, they are not included in the package.



APZ12 Optimal

APZ12: 85 mm

63 l/min

Grids for APZ12 Optimal

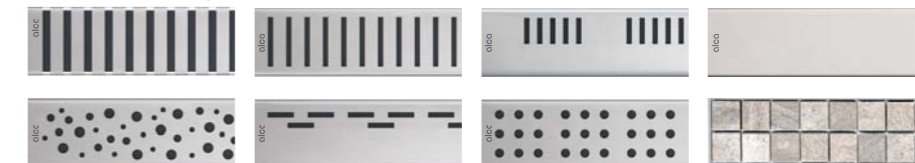

LINEAR PLASTIC SHOWER DRAIN WITH  
A FIXED VERTICAL FLANGE TO THE WALL

# Even more options



## APZ30 Wall

Linear plastic shower drain  
with a fixed vertical flange  
to the wall

→ see p. 46

**6** year warranty

 Online configurator  
[www.alcadrain.com/selection-guide](http://www.alcadrain.com/selection-guide)

**alca**

## A bestseller design in shower drains to the wall

### Linear plastic shower drain APZ30 Wall with a fixed vertical flange to the wall

The traditional plastic shower drain  
APZ10 Simple is now available with  
a fixed flange to the wall as APZ30 Wall.  
Choose the solution that best suits your  
needs – to the wall or into the space.



 all in package



### Advantages of placing the shower drain to the wall

A shower drain placed to the wall will provide  
reliable and discreet service. It will allow your  
pavement to better stand out and highlight  
the elegance of the shower enclosure. Easier  
floor sloping in a single direction is just  
an extra bonus.

### For all types of tiles

The vertical flange with a fixed distance of  
16 mm from the shower drain body edge can  
suit wall tiles of 6–12 mm in thickness.

# Modern, available



## APZ10BLACK-BRASS Simple

Shower drain in black-matt finish with perforated grid

### Variants of black plastic shower drains

- APZ10BLACK Simple
- APZ10BLACK-BRASS Simple
- APZ19BLACK Simple
- APZ20 Simple

→ see p. 47-48

**6** year warranty

Online configurator  
[www.alcadrain.com/selection-guide](http://www.alcadrain.com/selection-guide)

alca

## Traditional plastic shower drain in the non-traditional look conception

### Linear plastic shower drain APZ10BLACK

You can now brighten up your bathroom with a plastic shower drain in black-matt or brass finish. Resistant surface treatment ensures long life and easy maintenance.



all in package

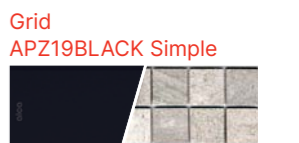
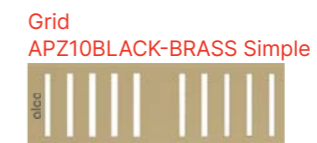
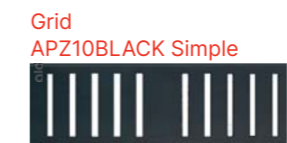

## Comprehensive black-matt program

- Flush plates
- Bath wastes and traps
- Shower wastes and traps
- Wash-basin traps
- Wash-basin wastes
- Angle valves
- Plastic shower drains
- Floor drains

[www.alcadrain.com/en/program-black-matt](http://www.alcadrain.com/en/program-black-matt)



PLASTIC LINEAR SHOWER DRAIN  
WITH A STAINLESS STEEL EDGE

# Stainless steel edge, two-sided grid



## APZ20 Simple

Shower drain with a stainless steel edge and perforated grid

**6** year warranty

Online configurator  
[www.alcadrain.com/selection-guide](http://www.alcadrain.com/selection-guide)

alca

## The economic variant for the perfect look

### Plastic linear shower drain with stainless steel edge

The optimal price quality ratio present an economical solution in segment of shower drains. The grid and the edge of plastic shower drain are made of high quality stainless steel. Other plastic parts of the shower drain and odour trap remain hidden in the floor.



### Shower drain APZ20 Simple with stainless steel edge

Due to the low installation height of 62 mm plastic shower drain APZ20 is particularly suitable for reconstruction of residential buildings. They are made of highly durable plastic that resists frost and chemicals.

Grid APZ20 Simple



 all in package



←  
**APZ20 Simple  
with stainless steel edge  
+ grid APZ20 Simple**

Shower drain with stainless steel edge and grid APZ20 Simple



# Beauty endures

Online configurator  
[www.alcadrain.com/selection-guide](http://www.alcadrain.com/selection-guide)

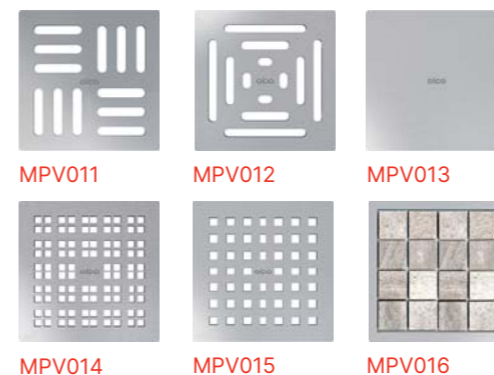

### Pinnacle of floor drain design

This new model of indoor drainage system was created as an alternative to our classic stainless steel shower drains. It gives customers another interesting option of bathroom drainage, while maintaining superior technical features and exceptional modern design. For those who prefer floor drains, or who for various reasons can not use shower drains, these stainless steel floor drains are a clear choice.

#### Three height options of traps

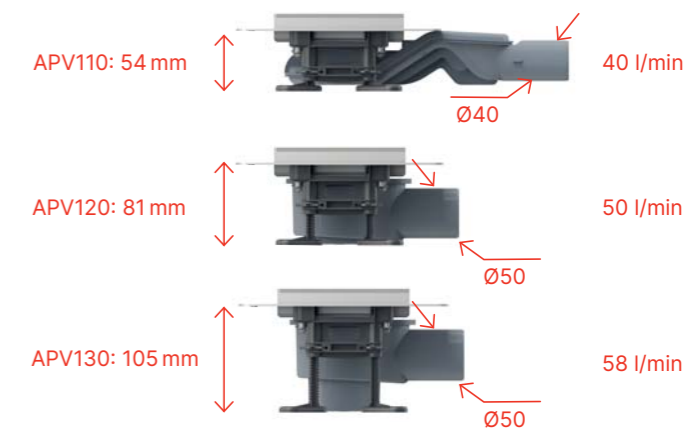

#### Combined odour trap is included in the packaging



### Floor drain with two-sided grid

Stainless steel floor drain with two-sided stainless steel grid, 130×130 mm, DN110, without odour trap. Suitable for embedding tiles with a thickness of 12 mm.

The inlet can be connected directly to the sewer, or it can be supplemented with a trap with a side or direct drain.

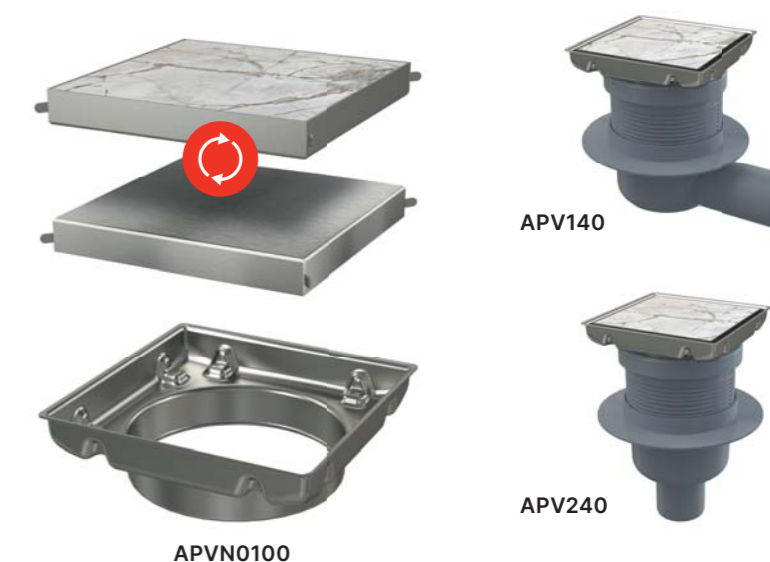

### APV110 + grid MPV013

Floor drain stainless steel extra-low with full grid

#### Variants of stainless steel floor drains

- APV110
- APV120
- APV130

→ see p. 45

**25** year warranty

**new**

# Specifications of Alca shower drains

## Low installation height

### Low installation height:

from 55 mm for drains with an outlet pipe diameter of 40 mm (suitable for renovations).  
from 85 mm for drains with an outlet pipe diameter of 50 mm (suitable for new buildings).

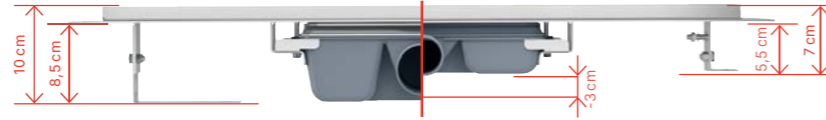

## 25 year warranty

### Material used:

Stainless Steel DIN 1.4301.

### Treatments of materials employed:

Pickling and passivation, electrochemical polishing.

### Protection against dirt during installation:

The collar and trap are protected by foil, and the channel itself by a styrofoam insert.

**25** year warranty

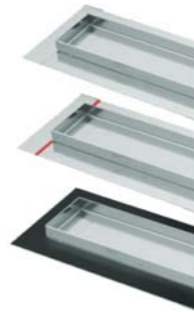

## High flow rate (up to 68 l/min)

### Maximum water flow rate:

68 l/min for drains with an outlet pipe diameter of 50 mm.  
44 l/min for drains with an outlet pipe diameter of 40 mm.

### Two traps in one:

The high flow rate achieved by the double compartment trap system.

### Standard:

EN 1253-1



## Completely cleanable trap

### Material:

polypropylene

### Construction:

2 outlet compartments, 2 removable inlet parts and 2 protective grid traps.

### Cleanability:

The protective grid trap will catch most of the dirt, but by removing it and the inlet part you can clean the drain all the way to the waste pipe.

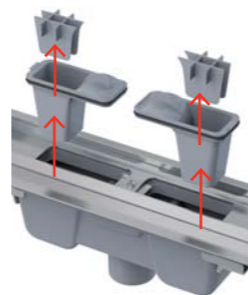

## Combined dry odour trap

### Optional accessories for stainless steel shower drains

For areas such as recreation facilities, utility rooms and premises with seasonal use the problem associated with the possibility of drying out of the water trap can be eliminated by installation of a combined odour trap.

**P095** for stainless steel shower drains APZ1, APZ4, APZ5, APZ6, APZ15, APZ16, APZ11, APZ1001, APZ1004, APZ1006, APZ1016, ARZ1



If there is no water flow through the waste, the flaps remain closed and even when the water seal dries out they still prevent odours rising from the sewer.



In normal use the flaps open and close to allow the water to drain out.



**P143, P144, P145** for stainless steel shower drain APZ13, APZ23 and for stainless steel floor drains APV110, APV120, APV130



Online configurator  
[www.alcadrain.com/selection-guide](http://www.alcadrain.com/selection-guide)

alca

## Complete package includes all accessories

### Complete package includes all accessories:

- Shower drain pre-assembled with a trap
- Installation set (bolts, plugs)
- Waterproofing tape
- Protective foil covering for the collar and inlet pipe, and protective insert for drainage channel



## Tailor made solutions available

**Length range:** 300–2,200 mm for a single section. Lengths greater than 2,200 mm can be achieved by connecting sections as required.

**Height variants:** Different edge heights and depths of the drainage channel can be supplied on request.

**Odour trap:** Can be positioned wherever the customer wishes. Depending on the water flow, more than one trap can be used in a single drain.

**Material:** Standard stainless steel DIN 1.4301. For aggressive environments (swimming pools) stainless steel DIN 1.4404.

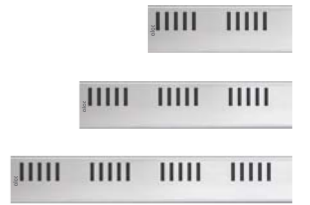

## Maintenance

### Grid maintenance

To maintain a perfect look, clean the system at least once a month. Do not use sharp objects or abrasives for cleaning as that can damage the surface of the grid.  
Video tutorial on [www.alcadrain.com](http://www.alcadrain.com)



1 shower drain Alca

2 odour trap

3 podkladový beton

4 oundation slab

5 primer coat

6 waterproofing tape

7 waterproofing material

8 adhesive

9 tiles

10 flexible filler

11 installation legs

12 grid Alca

# Stainless steel linear shower drains

## For a perforated grid

**APZ1, APZ101 Low, APZ1BLACK, APZ101BLACK Low**  
Shower drain with an edge for perforated grid  
(300, 550, 650, 750, 850, 950, 1050, 1150, 1450 mm)  
Atypical lengths upon request.

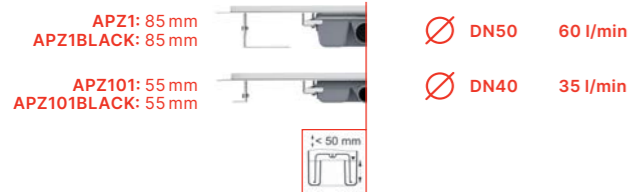

**APZ1001, APZ1101 Low**  
Shower drain with an edge for perforated grid, bottom outlet  
(300, 550, 650, 750, 850, 950, 1050, 1150, 1450 mm)  
Atypical lengths upon request.

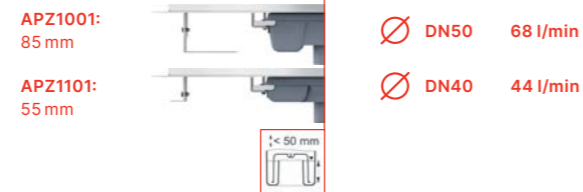

**APZ4 Flexible, APZ104 Flexible Low**  
Shower drain with an edge for perforated grid and with adjustable vertical flange to the wall  
(550, 650, 750, 850, 950, 1050, 1150 mm)

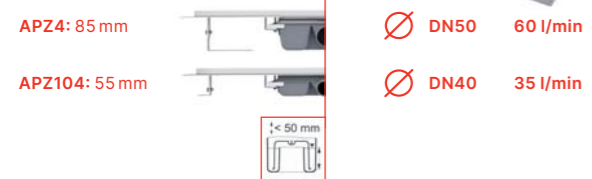

**APZ1004 Flexible, APZ1104 Flexible Low**  
Shower drain with an edge for perforated grid with an adjustable vertical flange to the wall, bottom outlet  
(550, 650, 750, 850, 950, 1050, 1150 mm)

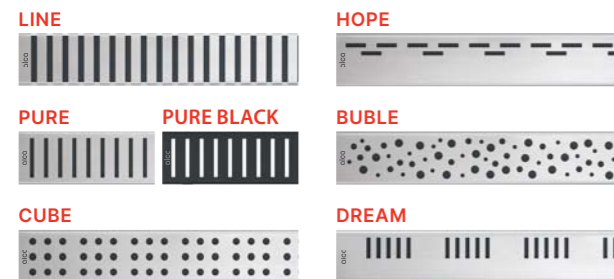
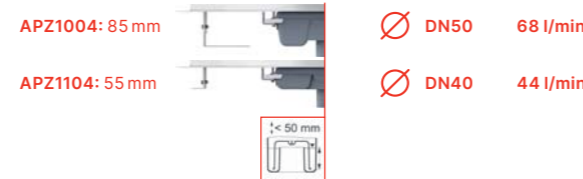

**APZ2001**  
Shower drain with an edge for perforated grid, without an odour trap  
(300, 550, 650, 750, 850, 950, 1050, 1150 mm)  
Atypical lengths upon request.



## For full grids

**APZ6 Professional, APZ106 Professional Low**  
Shower drain with an edge for full grid  
(300, 550, 650, 750, 850, 950, 1050, 1150 mm)  
Atypical lengths upon request.

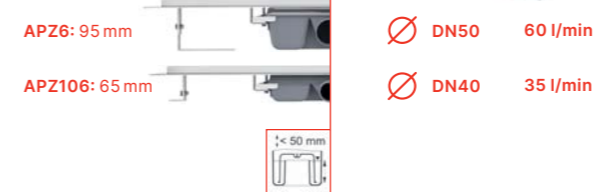

**APZ1006 Professional, APZ1106 Professional Low**  
Shower drain with an edge for full grid, bottom outlet  
(300, 550, 650, 750, 850, 950, 1050, 1150 mm)  
Atypical lengths upon request.

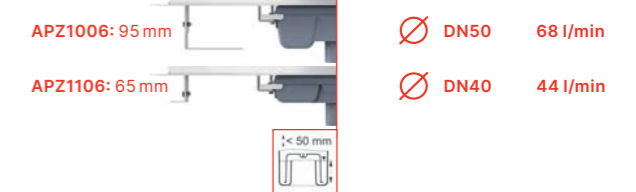

**APZ16 Wall, APZ116 Wall Low**  
Shower drain with edge for full grid and with fixed vertical flange to the wall  
(300, 550, 650, 750, 850, 950, 1050, 1150 mm)  
Atypical lengths upon request.

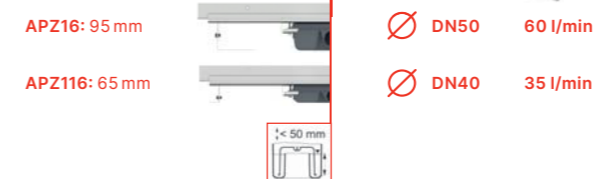

**APZ1016 Wall, APZ1116 Wall Low**  
Shower drain with an edge for full grid with an fixed vertical flange to the wall, bottom outlet  
(300, 550, 650, 750, 850, 950, 1050, 1150 mm)  
Atypical lengths upon request.

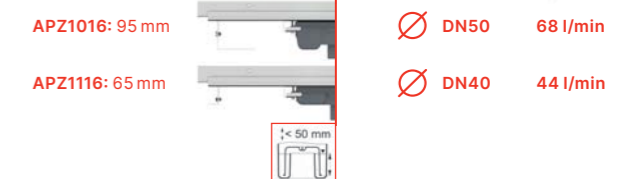

**APZ15 Marble, APZ115 Marble Low**  
Shower drain without edge with grid for embedding tiles  
(300, 550, 650, 750, 850, 950, 1050, 1150 mm)  
Atypical lengths upon request.

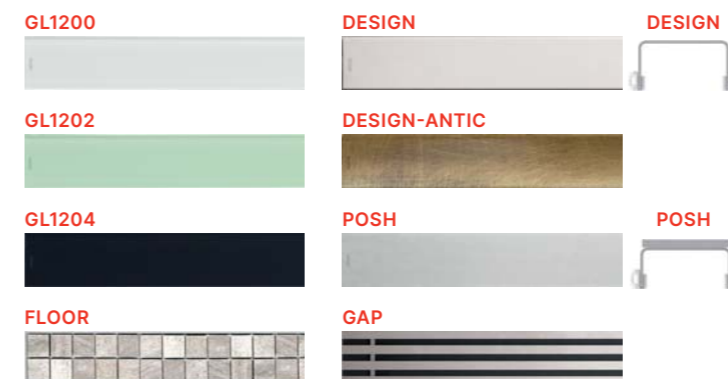
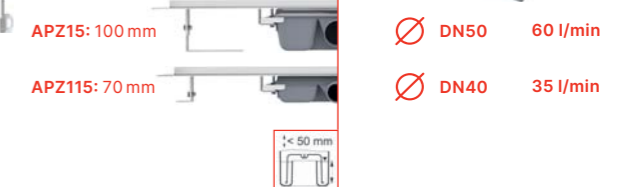

# Stainless steel linear shower drains

## Stainless steel shower drains APZ13-DOUBLE9 Fit and Go, APZ23-DOUBLE9 Fit and Go Wall

APZ13-DOUBLE9 Fit and Go  
Shower drain (550, 650, 750, 850, 950 mm)



**all in package**

- Package content
- Shower drain
  - Two-sided grid DOUBLE (full grid or grid for tile embedding)
  - Waterproof tape at the length of the linear drain
  - Low odour trap APZ-S9
  - Combined odour trap SMART
  - Anchoring kit (screws, dowels)
  - Installation legs
  - Dismantling hook



APZ23-DOUBLE9 Fit and Go Wall  
Shower drain (750, 850, 950 mm)



**all in package**

- Package content
- Shower drain to the wall
  - two-sided grid DOUBLE (full grid or grid for tile embedding)
  - Waterproof tape at the length of the linear drain
  - Low odour trap APZ-S9
  - Combined odour trap SMART
  - Anchoring kit (screws, dowels)
  - Installation legs
  - Dismantling hook



## Stainless steel shower drains APZ13 Modular, APZ23 Modular Wall

Configuration of the shower drain APZ13 Modular, APZ23 Modular Wall

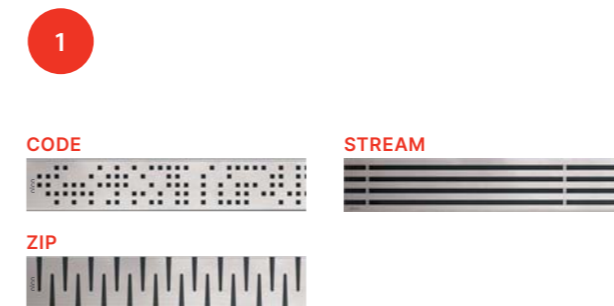
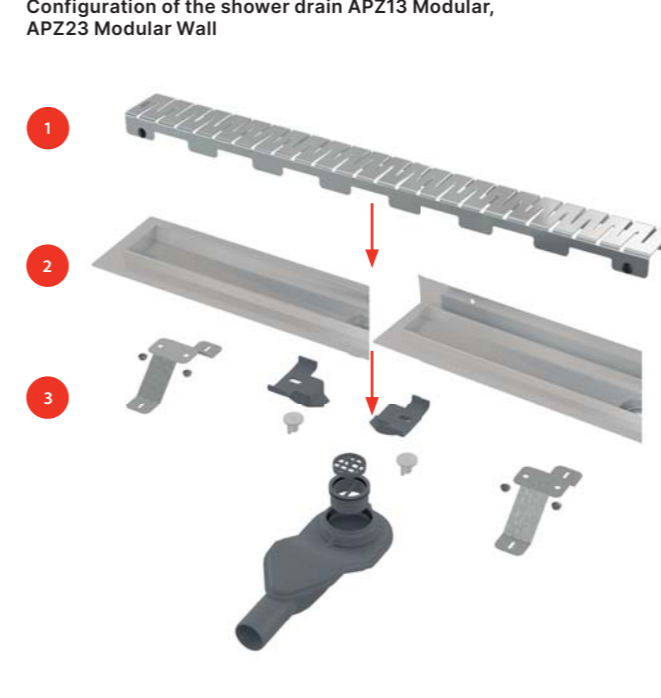

### Optional accessories



# Stainless steel linear shower drain

## Waste system in wall

**APZ5 Spa**  
Waste system for installation in walls  
(650, 750, 850, 950, 1050 mm)



APZ5: 100 mm  $\varnothing$  DN50 60 l/min

all in package

## ALCA LIGHT

APZ5 Spa backlight		Length varieties of backlighting for APZ5 Spa shower drains				
Lighting colour	Length of the drain (mm)	650	750	850	950	1 050
White	Code of backlighting in the length of the drain	AEZ 120-650	AEZ 120-750	AEZ 120-850	AEZ 120-950	AEZ 120-1050
Blue		AEZ 121-650	AEZ 121-750	AEZ 121-850	AEZ 121-950	AEZ 121-1050
Green		AEZ 122-650	AEZ 122-750	AEZ 122-850	AEZ 122-950	AEZ 122-1050
Red		AEZ 123-650	AEZ 123-750	AEZ 123-850	AEZ 123-950	AEZ 123-1050
Rainbow		AEZ 124-650	AEZ 124-750	AEZ 124-850	AEZ 124-950	AEZ 124-1050

Source for backlighting APZ5 Spa – AEZ 320

## Antivandal

**APZ11 Antivandal, APZ111 Antivandal Low**  
Shower drain Antivandal with grid  
(300, 550, 650, 750, 850, 950, 1050, 1150 mm)



APZ11: 85 mm  $\varnothing$  DN50 60 l/min

APZ111: 55 mm  $\varnothing$  DN40 35 l/min



all in package

The grid is included

## Stainless steel strips for sloping floors in showers



Code	Flange height	Length (mm)	Type	Version
APZ901M/1000	12	1000	left	matt
APZ902M/1000	12	1000	right	matt
APZ903M/1000	14	1000	left	matt
APZ904M/1000	14	1000	right	matt
APZ901M/1200	12	1200	left	matt
APZ902M/1200	12	1200	right	matt
APZ903M/1200	14	1200	left	matt
APZ904M/1200	14	1200	right	matt
APZ901M/1600	12	1200	left	matt
APZ902M/1600	12	1200	right	matt
APZ903M/1600	14	1200	left	matt
APZ904M/1600	14	1200	right	matt
APZ905M/1000	12	1000	double-sided	matt
APZ905M/1200	12	1200	double-sided	matt
APZ906M/1000	14	1000	double-sided	matt
APZ906M/1200	14	1200	double-sided	matt

Online configurator  
[www.alcadrain.com/selection-guide](http://www.alcadrain.com/selection-guide)

alca

## Stainless steel corner shower drains

all in package

**ARZ1**  
Corner shower drain without an edge for perforated grids



ARZ1: 100 mm  $\varnothing$  DN50 60 l/min

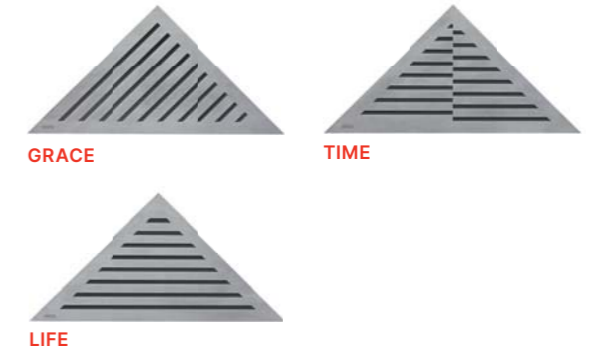

## Stainless steel floor drains

all in package

**APV110**  
Floor drain stainless steel extra-low  
130x130 mm side outlet, without grid,  
Combined odour trap SMART



APV110: 54 mm

$\varnothing$  DN40 40 l/min



**APV120**  
Floor drain stainless steel low 130x130 mm  
side outlet, without grid, Combined odour  
trap SMART



APV120: 81 mm

$\varnothing$  DN50 50 l/min



**APV130**  
Floor drain stainless steel 130x130 mm  
side outlet, without grid, wet odour trap



APV130: 105 mm

$\varnothing$  DN50 58 l/min

## Combined odour trap in the package



**APVN0100**  
Drain throat extension neck + Two-sided grid  
130x130, stainless steel

new



**APV140**  
Floor drain 130x130 mm side outlet,  
stainless steel grid, wet odour trap

new



**APV240**  
Floor drain 130x130 mm straight outlet,  
stainless steel grid, wet odour trap

new



# Plastic linear shower drains

## For a perforated grid

**APZ9 Simple**  
Shower drain with an edge for perforated grid (550, 650, 750, 850, 950 mm)

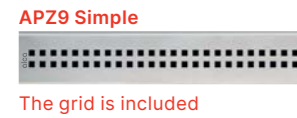

The grid is included

**APZ10 Simple**  
Shower drain with an edge for perforated grid (550, 650, 750, 850, 950 mm)



The grid is included

**APZ30 Wall**  
Shower drain with an edge for perforated grid (650, 750, 850 mm)

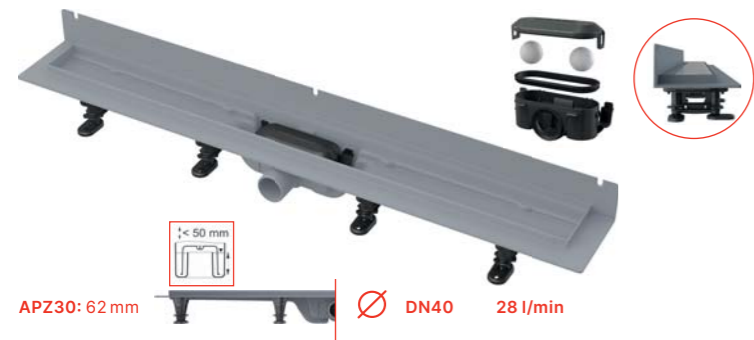

The grid is included



- Package content
- Shower drain
  - Grid
  - Waterproof tape at the length of the linear drain
  - Combined odour SMART trap
  - Anchoring kit (screws, dowels)
  - Installation legs
  - Dismantling hook



- Package content
- Shower drain
  - Grid
  - Waterproof tape at the length of the linear drain
  - Combined odour SMART trap
  - Anchoring kit (screws, dowels)
  - Installation legs
  - Dismantling hook



- Package content
- Shower drain
  - Grid
  - Waterproof tape at the length of the linear drain
  - Combined odour SMART trap
  - Anchoring kit (screws, dowels)
  - Installation legs
  - Dismantling hook



Online configurator  
[www.alcadrain.com/selection-guide](http://www.alcadrain.com/selection-guide)

alca

**APZ10BLACK Simple**  
Shower drain with an edge for perforated grid, black-matt (550, 650, 750, 850, 950 mm)



The grid is included

**APZ10BLACK-BRASS Simple**  
Shower drain with an edge for perforated grid, brass (550, 650, 750, 850, 950 mm)



The grid is included



- Package content
- Shower drain
  - Grid
  - Waterproof tape at the length of the linear drain
  - Combined odour SMART trap
  - Anchoring kit (screws, dowels)
  - Installation legs
  - Dismantling hook



- Package content
- Shower drain
  - Grid
  - Waterproof tape at the length of the linear drain
  - Combined odour SMART trap
  - Anchoring kit (screws, dowels)
  - Installation legs
  - Dismantling hook



# Plastic linear shower drains

## For two-sided grid

**APZ19 Simple**  
Shower drain with an edge for two-sided grid (550, 650, 750, 850, 950 mm)



**APZ19BLACK Simple**  
Shower drain with an edge for two-sided grid, black-matt (550, 650, 750, 850, 950 mm)



**APZ20 Simple**  
Shower drain with a stainless steel edge for two-sided grid (550, 650, 750, 850, 950 mm)

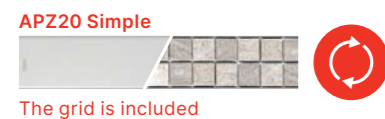

- Package content
- Shower drain
  - Grid
  - Waterproof tape at the length of the linear drain
  - Combined odour SMART trap
  - Anchoring kit (screws, dowels)
  - Installation legs
  - Dismantling hook



- Package content
- Shower drain
  - Grid
  - Waterproof tape at the length of the linear drain
  - Combined odour SMART trap
  - Anchoring kit (screws, dowels)
  - Installation legs
  - Dismantling hook



- Package content
- Shower drain
  - Grid
  - Waterproof tape at the length of the linear drain
  - Combined odour SMART trap
  - Anchoring kit (screws, dowels)
  - Installation legs
  - Dismantling hook



## For perforated grid, full grid or grid for embedding tiles

**APZ12 Optimal**  
Shower drain with an edge for perforated grids or tile embedding (650, 750, 850, 950, 1050 mm)

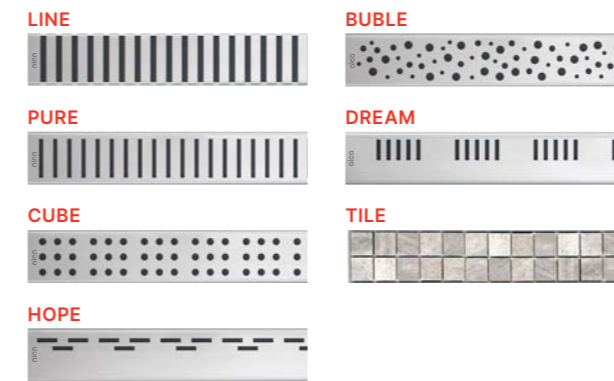

# alca GROUP

Respect, reliability, innovation.  
These are our values. We are Alca Group.



Complete assortment of sanitary technology,  
system walls and piping systems

## alca

### Sanitary technology, system walls

Alca was founded in 1998, since 2021 it is part of the Alca Group. The largest manufacturer of sanitary ware in Central and Eastern Europe on an area of over 110,000 m<sup>2</sup>, it produces more than 1,000 sanitary products – valves, traps, WC systems, shower drains, floor drains, toilet seats and other assortment.

Furthermore it is a manufacturer of prefabricated system walls Alcasystem. This modular system for dry construction offers a complex solution for water supply, waste, electrical installation, sanitary technology and sound insulation, making it ideal for medium and large projects.



## International branches

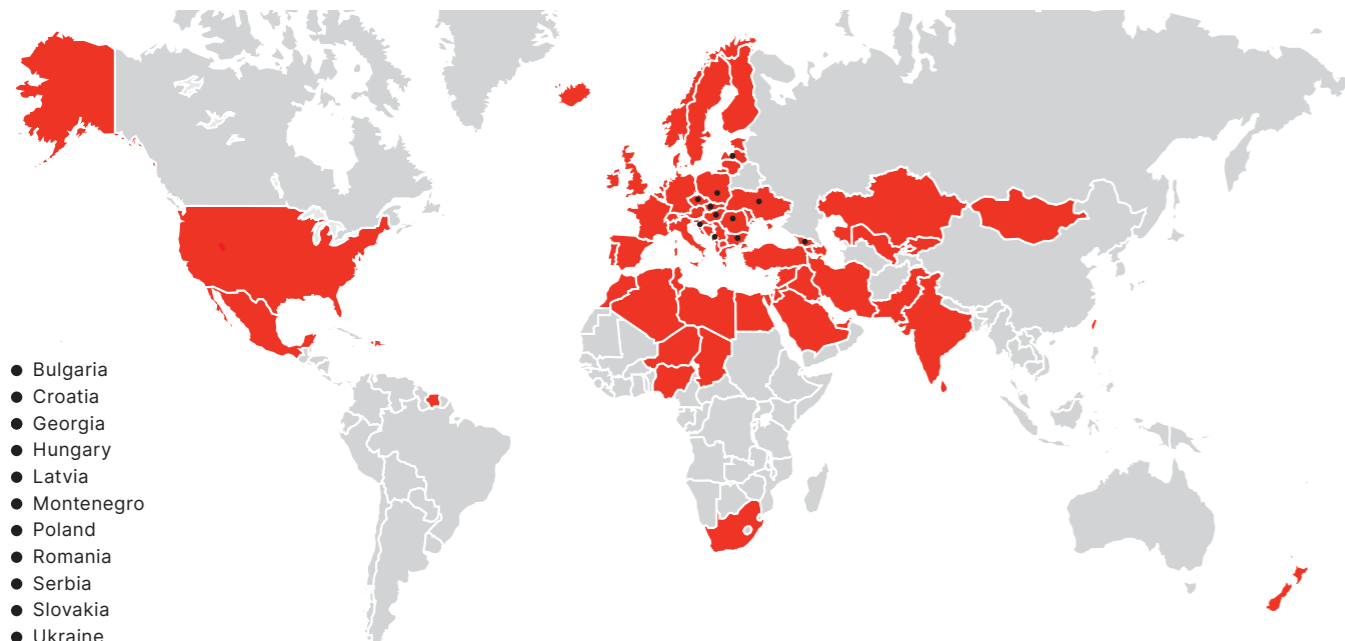

## FV PLAST

### Piping systems, floor heating and ceiling cooling systems

FV - Plast was founded in 1990 and has been part of the Alca Group since 2021. Since its establishment, it has been involved in the production of a complete range of pipe systems for water distribution and heating. The product portfolio also includes floor heating and ceiling cooling systems. Currently, FV - Plast is the largest producer of PP-RCT pipes in Central Europe and the only Czech producer of PERT and AL-PERT pipes.



# alca GROUP

alca

Sanitary technology,  
system walls

Czech Republic  
Alcadrain s.r.o.  
Komunardů 1626/35  
170 00 Praha 7 – Holešovice  
T: +420 519 821 117 – sale  
T: +420 519 821 041 – export  
alcadrain@alcadrain.com  
www.alcadrain.com

FV  
PLAST

Piping systems, floor heating  
and ceiling cooling systems

Czech Republic  
FV – Plast a.s.  
Kozovazská 1049/3  
250 88 Čelákovice  
T: +420 326 706 711  
fv-plast@fv-plast.cz  
www.fvplast.com

Our team of specialists is always on hand to help with design, installation and quote project prices.

The warranty stated for individual products applies only to the functional technical properties of the product, does not apply to wear and tear of the product caused by its normal use or defects caused by non-compliance with general product handling principles or non-compliance with product instructions. Complete warranty conditions at [www.alcadrain.com/guarantee](http://www.alcadrain.com/guarantee).



Czech manufacturer, ISO 9001:2015  
Edition 2/2024 EN, © Alcadrain s.r.o.  
Changes in dimensions and design reserved.